



2 0 2 2 P R O D U C T G U I D E





- AZEK® Decking 4
- AZEK® Porch 7
- PRO™ Decking 8
- EDGE™ Decking 11
- Specialty Decking 12
- Decking Accessories..... 13
- Decking Fasteners 14
- Composite Railing..... 18
- Metal Railing 28
- Composite ADA Railing 34
- Metal ADA Railing..... 35
- Railing Accessories..... 36
- Lighting 37
- DrySpace..... 39



- AZEK Trim42
- AZEK Moulding..... 48
- AZEK Siding 52
- AZEK Board and Batten 53
- AZEK Cladding..... 53
- AZEK Adhesive and Tools..... 54
- AZEK Cortex..... 56

Decking Quick Comparison Chart

Easily compare Capped Composite and Capped Polymer decking options to best suit your performance, design, and budgetary needs.

| | TimberTech EDGE | | | TimberTech PRO | | | TimberTech AZEK | | |
|------------------------------|--|--|--|--|--|--|--|--|--|
| Collection | PRIME+™ | PREMIER | TERRAIN® | RESERVE | LEGACY | HARVEST® | LANDMARK™ | VINTAGE® | |
| OVERALL QUALITY | GOOD | GOOD | BETTER | BEST | BEST | BETTER | BEST | PREMIUM | |
| Board Material | Capped Composite | Capped Composite | Capped Composite | Capped Composite | Capped Composite | Capped Polymer | Capped Polymer | Capped Polymer | |
| Limited Residential Warranty | 25 Years | 25 Years | 30 Years | 30 Years | 30 Years | Lifetime | Lifetime | Lifetime | |
| Limited Commercial Warranty | 10 Years | 10 Years | 10 Years | 10 Years | 10 Years | 20 Years | 20 Years | 20 Years | |
| Fade & Stain Warranty | 25 Years | 25 Years | 30 Years | 30 Years | 30 Years | 50 Years | 50 Years | 50 Years | |
| Profile & Capping |  3-Sided |  3-Sided |  4-Sided |  4-Sided |  4-Sided |  3-Sided |  4-Sided |  4-Sided | |
| Moisture Resistance | Good | Good | Better | Better | Better | Best | Best | Best | |
| Grain Pattern | Straight | Straight | Cathedral | Cathedral & Wire-Brushed | Hand-Scraped | Cathedral | Cathedral & Cross-cut | Wire-Brushed | |
| Color Blending | Blended | Solid | Solid or Blended | Blended | Highly Blended | Solid | Highly Blended | Highly Blended | |
| PRICE | \$ | \$ | \$\$ | \$\$\$ | \$\$\$ | \$\$ | \$\$\$ | \$\$\$\$ | |

PERFORMANCE

DESIGN

Common Decking Terms

Color Blending

Subtle to bold streaking of lighter and darker colors to resemble premium hardwoods.

Capping

Surface layer that protects against mold, mildew, moisture damage, scratches, fading, and staining.

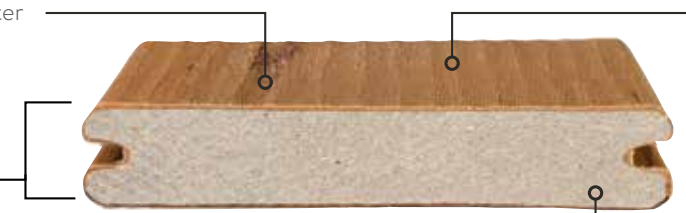

Grain Pattern

The texture and finish on the board, representing a variety of wood species and treatments.

Board Material

The material composition of the core, either Composite or Capped Polymer.

PRO TIP: For second floor applications or where the bottom of the board is visible, choose a 4-sided capped collection for best aesthetics.





TIMBERTECH® AZEK® DECKING

Bring the advanced material technology in both the cap and core of TimberTech decking to your backyard. TimberTech AZEK Decking offers up to 40% better slip resistance than competitors' decking, stays cooler on sunny days, and has superior resistance to the elements. Made from approximately 50% recycled material and significantly more sustainable than premium hardwood. From premium performance to stylish sophistication, TimberTech decking is revolutionizing outdoor living with long-lasting, low-maintenance, and beautifully natural looking decking options.



Photo: Vintage Collection® Dark Hickory

Vintage Collection®

RICH. SOPHISTICATED. STYLISH.



Wildland Urban Interface Approved
8110-2042:0001
SFM 12-7A-4A

Explore the "Designer Series" of decking to make every outdoor living space a masterpiece. This sophisticated collection features the most natural-looking colors with a subtle wire-brushed, low-gloss finish for a truly authentic wood look. This collection is rated a Class A on the Flame Spread Index.



| PRODUCT DESCRIPTION | TimberTech Model Number | | |
|--------------------------------------|-------------------------|-------------|-------------|
| | 12' | 16' | 20' |
| VINTAGE COLLECTION® | | | |
| 1 x 4 Square Shoulder Coastline | — | ADB13516CS | ADB13520CS |
| 1 x 6 Square Shoulder Coastline | — | ADB15516CS | ADB15520CS |
| 2 x 6 Square Shoulder Coastline MAX | ADB25512CS | ADB25516CS | ADB25520CS |
| 1 x 6 Grooved Coastline | AGB15512CS | AGB15516CS | AGB15520CS |
| 1 x 8 Square Shoulder Coastline | — | ADB172516CS | ADB172520CS |
| 1 x 4 Square Shoulder English Walnut | — | ADB13516EW | ADB13520EW |
| 1 x 6 Square Shoulder English Walnut | — | ADB15516EW | ADB15520EW |
| 1 x 6 Grooved English Walnut | AGB15512EW | AGB15516EW | AGB15520EW |
| 1 x 8 Square Shoulder English Walnut | — | ADB172516EW | ADB172520EW |
| 1 x 4 Square Shoulder Weathered Teak | — | ADB13516WT | ADB13520WT |
| 1 x 6 Square Shoulder Weathered Teak | — | ADB15516WT | ADB15520WT |
| 1 x 6 Grooved Weathered Teak | AGB15512WT | AGB15516WT | AGB15520WT |
| 1 x 8 Square Shoulder Weathered Teak | — | ADB172516WT | ADB172520WT |
| 1 x 4 Square Shoulder Mahogany | — | ADB13516MH | ADB13520MH |
| 1 x 6 Square Shoulder Mahogany | — | ADB15516MH | ADB15520MH |
| 1 x 6 Grooved Mahogany | AGB15512MH | AGB15516MH | AGB15520MH |
| 1 x 8 Square Shoulder Mahogany | — | ADB172516MH | ADB172520MH |
| 1 x 4 Square Shoulder Dark Hickory | — | ADB13516DH | ADB13520DH |
| 1 x 6 Square Shoulder Dark Hickory | — | ADB15516DH | ADB15520DH |
| 1 x 6 Grooved Dark Hickory | AGB15512DH | AGB15516DH | AGB15520DH |
| 1 x 8 Square Shoulder Dark Hickory | — | ADB172516DH | ADB172520DH |
| 1 x 4 Square Shoulder Cypress | — | ADB13516CY | ADB13520CY |
| 1 x 6 Square Shoulder Cypress | — | ADB15516CY | ADB15520CY |
| 1 x 6 Grooved Cypress | AGB15512CY | AGB15516CY | AGB15520CY |
| 1 x 8 Square Shoulder Cypress | — | ADB172516CY | ADB172520CY |
| VINTAGE FASCIA | | | |
| 12" Fascia Coastline | ADR5117512CS | — | — |
| 12" Fascia English Walnut | ADR5117512EW | — | — |
| 12" Fascia Weathered Teak | ADR5117512WT | — | — |
| 12" Fascia Mahogany | ADR5117512MH | — | — |
| 12" Fascia Dark Hickory | ADR5117512DH | — | — |
| 12" Fascia Cypress | ADR5117512CY | — | — |

Multi-Width Decking

NARROW. STANDARD. WIDE.

Standard width decking is not the standard any longer. Narrow and wide width decking is available in all Vintage Collection® colors. Additionally, the Harvest Collection® offers two wide width colors.

MAX Decking

STRONG AND STURDY

MAX capped polymer boards are 1.5" thick and span 24" on center, perfect for docks, boardwalks, and many commercial applications.

Profile Options

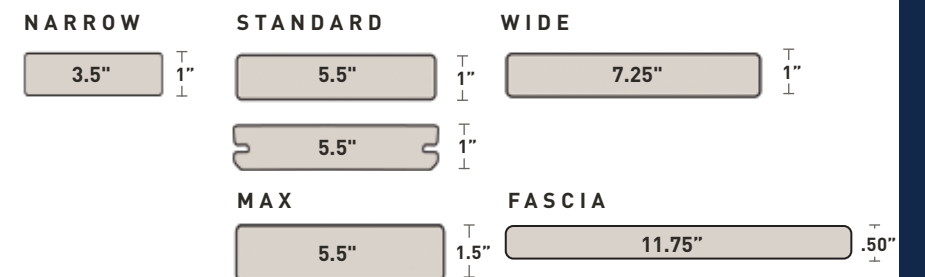

Landmark Collection™

REFINED. RUSTIC. UNIQUE.

Deck out your outdoor living space with the modern wood tones from this collection. Based off of reclaimed lumber, the classic cathedral grain pattern is complemented by a rustic crosscut grain and matte finish. The color-blending in these decking boards has cascading hues which result in natural color variation. And, just like in nature, the highlights and lowlights in each board's color vary from end-to-end and board-to-board making each deck unique.



FRENCH WHITE OAK® **CASTLE GATE™** **AMERICAN WALNUT®**

| PRODUCT DESCRIPTION | TimberTech Model Number | | |
|--|-------------------------|------------|------------|
| | 12' | 16' | 20' |
| LANDMARK COLLECTION™ | | | |
| 1 x 6 Square Shoulder Castle Gate™ | — | ADB15516CG | ADB15520CG |
| 1 x 6 Grooved Castle Gate™ | AGB15512CG | AGB15516CG | AGB15520CG |
| 1 x 6 Square Shoulder American Walnut™ | — | ADB15516AW | ADB15520AW |
| 1 x 6 Grooved American Walnut™ | AGB15512AW | AGB15516AW | AGB15520AW |
| 1 x 6 Square French White Oak® | — | ADB15516FW | ADB15520FW |
| 1 x 6 Grooved French White Oak® | AGB15512FW | AGB15516FW | AGB15520FW |
| LANDMARK FASCIA | | | |
| 12" Fascia Castle Gate™ | ADR5117512CG | — | — |
| 12" Fascia American Walnut™ | ADR5117512AW | — | — |
| 12" Fascia French White Oak® | ADR5117512FW | — | — |

Profile Options

STANDARD

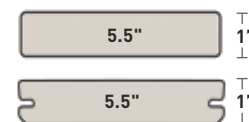

Harvest Collection®

WARM. NATURAL. EFFORTLESS.

This stylish collection offers solid color boards for a painted wood look. Composed of soft, natural shades, this collection complements most home's exteriors and offers a traditional cathedral wood grain pattern.



BROWNSTONE **SLATE GRAY** **KONA®**



| PRODUCT DESCRIPTION | TimberTech Model Number | | |
|--------------------------------------|-------------------------|---------------|---------------|
| | 12' | 16' | 20' |
| HARVEST COLLECTION® | | | |
| 1 x 6 Square Shoulder Brownstone | ADCB15512BS | ADCB15516BS | ADCB15520BS |
| 1 x 6 Grooved Brownstone | AGB15512BS | AGB15516BS | AGB15520BS |
| 1 x 8 Square Shoulder Brownstone | — | ADCB172516BS | ADCB172520BS |
| 1 x 6 Square Shoulder Slate Gray | ADCB15512SG | ADCB15516SG | ADCB15520SG |
| 1 x 6 Grooved Slate Gray | AGB15512SG | AGB15516SG | AGB15520SG |
| 1 x 8 Square Shoulder Slate Gray | — | ADCB172516SG | ADCB172520SG |
| 2 x 6 Square Shoulder Slate Gray MAX | ADCB25512SG | ADCB25516SG | ADCB25520SG |
| 1 x 6 Square Shoulder Kona® | — | ADB15516KOAAT | ADB15520KOAAT |
| HARVEST FASCIA | | | |
| 12" Fascia Brownstone | ADCR5117512BS | — | — |
| 12" Fascia Slate Gray | ADCR5117512SG | — | — |
| 12" Fascia Kona® | ADR5117512KOAAT | — | — |

Profile Options

STANDARD



MAX



WIDE

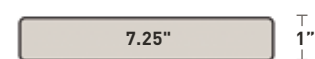

Photo: Slate Gray Porch



Porch

ELEGANT. STYLISH. DURABLE.

Forget curb appeal — it's all about porch appeal these days. Warm, natural-looking, and nuanced colors round out the Porch Collection to help create an inviting space to greet guests or simply lounge. With tongue and groove technology, these porch boards feature a tighter-fit between boards for a more polished look. Offered in both standard and wide width, you can make a style statement on your front porch.



| PRODUCT DESCRIPTION | TimberTech Model Number | | |
|--------------------------------|-------------------------|-------------|-------------|
| | 10' | 12' | 16' |
| AZEK PORCH | | | |
| 1 x 4 T&G Porch Slate Gray | ADCP13510SG | ADCP13512SG | ADCP13516SG |
| 1 x 4 T&G Porch Oyster | — | ADP13512OR | ADP13516OR |
| 1 x 6 T&G Porch Mahogany | — | ADP15512MH | ADP15516MH |
| 1 x 4 T&G Porch Mahogany | — | ADP13512MH | ADP13516MH |
| 1 x 6 T&G Porch Dark Hickory | — | ADP15512DH | ADP15516DH |
| 1 x 4 T&G Porch Dark Hickory | — | ADP13512DH | ADP13516DH |
| 1 x 6 T&G Porch Coastline | — | ADP15512CS | ADP15516CS |
| 1 x 4 T&G Porch Coastline | — | ADP13512CS | ADP13516CS |
| 1 x 6 T&G Porch Weathered Teak | — | ADP15512WT | ADP15516WT |
| 1 x 4 T&G Porch Weathered Teak | — | ADP13512WT | ADP13516WT |

*Extended lead times may apply to certain geographies.

Profile Options

STANDARD

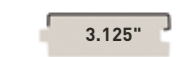

WIDE



TIMBERTECH® PRO® DECKING

Explore premium decking in bold, beautiful colors with exceptional cap protection. Boards in these collections are covered from top to bottom and in the grooves with advanced Mold Guard® Technology to prevent moisture damage. Composed of up to 80% recycled material and offering color options ranging from solid to infinitely variable, the TimberTech PRO decking line doesn't disappoint.



PHOTO: Legacy Collection Ashwood



Legacy Collection

BOLD. DRAMATIC. UNIQUE.

Stand apart from run-of-the-mill decks with this stunning, artisanal collection. This decking features a complex blend of several colors, natural board-to-board color variation, and a hand-scraped texture that offers old world charm. Just as every tree found in nature is unique, every deck board in the Legacy Collection is unique.

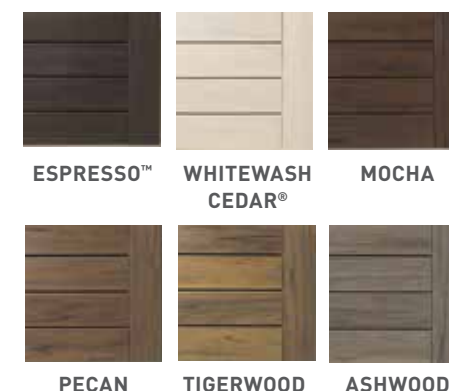

| PRODUCT DESCRIPTION | TimberTech Model Number | | |
|---------------------------------------|-------------------------|------------|------------|
| | 12' | 16' | 20' |
| LEGACY COLLECTION | | | |
| 1 x 6 Grooved Espresso | LCGV5412E | LCGV5416E | LCGV5420E |
| 1 x 6 Square Shoulder Espresso | — | LC5416E | LC5420E |
| 1 x 6 Grooved Whitewash Cedar | LCGV5412WC | LCGV5416WC | LCGV5420WC |
| 1 x 6 Square Shoulder Whitewash Cedar | — | LC5416WC | LC5420WC |
| 1 x 6 Grooved Mocha | LCGV5412M | LCGV5416M | LCGV5420M |
| 1 x 6 Square Shoulder Mocha | — | LC5416M | LC5420M |
| 1 x 6 Grooved Pecan | LCGV5412P | LCGV5416P | LCGV5420P |
| 1 x 6 Square Shoulder Pecan | — | LC5416P | LC5420P |
| 1 x 6 Grooved Tigerwood | LCGV5412TW | LCGV5416TW | LCGV5420TW |
| 1 x 6 Square Shoulder Tigerwood | — | LC5416TW | LC5420TW |
| 1 x 6 Grooved Ashwood | LCGV5412AW | LCGV5416AW | LCGV5420AW |
| 1 x 6 Square Shoulder Ashwood | — | LC5416AW | LC5420AW |
| LEGACY FASCIA | | | |
| 12" Fascia Espresso | FBLC12E | — | — |
| 12" Fascia Whitewash Cedar | FBLC12WC | — | — |
| 12" Fascia Mocha | FBLC12M | — | — |
| 12" Fascia Pecan | FBLC12P | — | — |
| 12" Fascia Tigerwood | FBLC12TW | — | — |
| 12" Fascia Ashwood | FBLC12AW | — | — |
| LEGACY RISER | | | |
| 7-1/4" Riser Espresso | LCRISERE | — | — |
| 7-1/4" Riser Whitewash Cedar | LCRISERWC | — | — |
| 7-1/4" Riser Mocha | LCRISERM | — | — |
| 7-1/4" Riser Pecan | LCRISERP | — | — |
| 7-1/4" Riser Tigerwood | LCRISERTW | — | — |
| 7-1/4" Riser Ashwood | LCRISERAW | — | — |

Profile Options

STANDARD



RISER



FASCIA

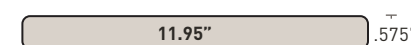

Reserve Collection

AUTHENTIC. RECLAIMED. INSPIRING.

Turn up the volume on composite decking with the complex coloring and striking wood grain visual from the colors of the Reserve Collection. Inspired by reclaimed wood, the heavy wire-brush finish highlights the classic cathedral wood grain and offers better slip resistance than competitors.

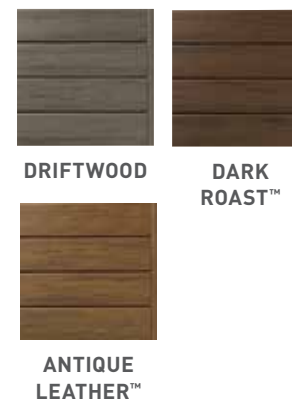

| PRODUCT DESCRIPTION | TimberTech Model Number | | |
|---------------------------------------|-------------------------|------------|------------|
| | 12' | 16' | 20' |
| RESERVE COLLECTION | | | |
| 1 x 6 Grooved Driftwood | RCGV5412DW | RCGV5416DW | RCGV5420DW |
| 1 x 6 Square Shoulder Driftwood | — | RC5416DW | RC5420DW |
| 1 x 6 Grooved Antique Leather | RCGV5412AL | RCGV5416AL | RCGV5420AL |
| 1 x 6 Square Shoulder Antique Leather | — | RC5416AL | RC5420AL |
| 1 x 6 Grooved Dark Roast | RCGV5412DR | RCGV5416DR | RCGV5420DR |
| 1 x 6 Square Shoulder Dark Roast | — | RC5416DR | RC5420DR |
| RESERVE FASCIA | | | |
| 12" Fascia Driftwood | FBRC12DW | — | — |
| 12" Fascia Antique Leather | FBRC12AL | — | — |
| 12" Fascia Dark Roast | FBRC12DR | — | — |
| RESERVE RISER | | | |
| 7-1/4" Riser Driftwood | RCRISERDW | — | — |
| 7-1/4" Riser Antique Leather | RCRISERAL | — | — |
| 7-1/4" Riser Dark Roast | RCRISERDR | — | — |

Profile Options

STANDARD

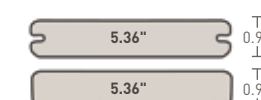

RISER

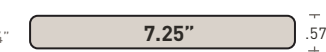

FASCIA

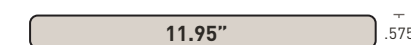

Terrain Collection®

TRADITIONAL. TIMELESS. RUGGED.

Tap into traditional and timeless hues for your outdoor oasis. Ranging from solid to minimally blended colors, these scalloped boards offer a complex, rugged wood grain pattern designed to camouflage wear and tear from everyday life. This practical collection is the perfect combination of value and performance.



RUSTIC ELM®

STONE ASH®



SILVER MAPLE

BROWN OAK



SANDY BIRCH

(SPECIAL ORDER)

| PRODUCT DESCRIPTION | TimberTech Model Number | | |
|------------------------------------|-------------------------|------------|------------|
| | 12' | 16' | 20' |
| TERRAIN COLLECTION™ | | | |
| 1 x 6 Grooved Brown Oak | TCGV5412BO | TCGV5416BO | TCGV5420BO |
| 1 x 6 Square Shoulder Brown Oak | — | TC5416BO | TC5420BO |
| 1 x 6 Grooved Silver Maple | TCGV5412SM | TCGV5416SM | TCGV5420SM |
| 1 x 6 Square Shoulder Silver Maple | — | TC5416SM | TC5420SM |
| 1 x 6 Grooved Rustic Elm | TCGV5412RE | TCGV5416RE | TCGV5420RE |
| 1 x 6 Square Shoulder Rustic Elm | — | TC5416RE | TC5420RE |
| 1 x 6 Grooved Stone Ash | TCGV5412SA | TCGV5416SA | TCGV5420SA |
| 1 x 6 Square Shoulder Stone Ash | — | TC5416SA | TC5420SA |
| 1 x 6 Grooved Sandy Birch | TCGV5412SB | TCGV5416SB | TCGV5420SB |
| 1 x 6 Square Sandy Birch | — | TC5416SB | TC5420SB |
| TERRAIN FASCIA | | | |
| 12" Fascia Brown Oak | FBTC12BO | — | — |
| 12" Fascia Silver Maple | FBTC12SM | — | — |
| 12" Fascia Rustic Elm | FBTC12RE | — | — |
| 12" Fascia Stone Ash | FBTC12SA | — | — |
| 12" Fascia Sandy Birch | FBTC12SB | — | — |
| TERRAIN RISER | | | |
| 7-1/4" Riser Brown Oak | TCRISERBO | — | — |
| 7-1/4" Riser Silver Maple | TCRISERSM | — | — |
| 7-1/4" Riser Rustic Elm | TCRISERRE | — | — |
| 7-1/4" Riser Stone Ash | TCRISERSA | — | — |
| 7-1/4" Riser Sandy Birch | FBTC12SA | — | — |

Profile Options

STANDARD

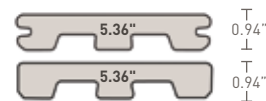

RISER

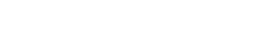

FASCIA



Photo: Terrain Collection® Rustic Elm



TIMBERTECH® EDGE® DECKING

Go Against the Grain® and step up into the world of long-lasting, low-maintenance, capped composite decking. This attainable composite decking line allows homeowners to ditch the costly and laborious maintenance that comes with traditional wood for good! Plus, it's composed of up to 80% recycled materials, making it the sustainable option.



Photo: Sea Salt Gray with Classic Composite Series Railing

Premier Collection

ALLURING. CLASSIC. SENSIBLE.

Design your ideal deck with the beautiful colors in this inspired decking collection. These full profile boards offer monochromatic colors for a painted wood visual and feature a subtle, straight wood grain pattern. Give your homeowners the long-lasting look that they've been craving with the Premier Collection.



MARITIME GRAY™

DARK TEAK™

| PRODUCT DESCRIPTION | TimberTech Model Number | | |
|-------------------------------------|-------------------------|------------|------------|
| | 12' | 16' | 20' |
| PREMIER COLLECTION | | | |
| 1 x 6 Grooved Dark Teak | EFGV5412DT | EFGV5416DT | EFGV5420DT |
| 1 x 6 Square Shoulder Dark Teak | — | EF5416DT | EF5420DT |
| 1 x 6 Grooved Maritime Gray | EFGV5412MG | EFGV5416MG | EFGV5420MG |
| 1 x 6 Square Shoulder Maritime Gray | — | EF5416MG | EF5420MG |
| PREMIER FASCIA | | | |
| 12" Fascia Dark Teak | FBE12DT | — | — |
| 12" Fascia Maritime Gray | FBE12MG | — | — |
| PREMIER RISER | | | |
| 7-1/4" Riser Dark Teak | ERISERDT | — | — |
| 7-1/4" Riser Maritime Gray | ERISERMG | — | — |

Profile Options

STANDARD



RISER



FASCIA

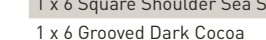
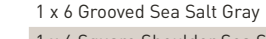

Prime+ Collection®

EYE-CATCHING. VIBRANT. ATTAINABLE.

Lean in to beautifully simple colors with this inspired decking collection. The moderately varied hues and subtle, straight grain pattern create an authentic wood visual. Get the look everyone is ditching wood for and choose the Prime+ Collection's scalloped boards.

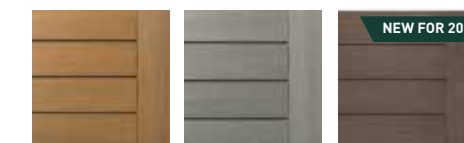

COCONUT HUSK™

SEA SALT GRAY

DARK COCOA

| PRODUCT DESCRIPTION | TimberTech Model Number | | |
|-------------------------------------|-------------------------|------------|------------|
| | 12' | 16' | 20' |
| PRIME+ COLLECTION | | | |
| 1 x 6 Grooved Coconut Husk | PRGV5412CH | PRGV5416CH | PRGV5420CH |
| 1 x 6 Square Shoulder Coconut Husk | — | PR5416CH | PR5420CH |
| 1 x 6 Grooved Sea Salt Gray | PRGV5412ST | PRGV5416ST | PRGV5420ST |
| 1 x 6 Square Shoulder Sea Salt Gray | — | PR5416ST | PR5420ST |
| 1 x 6 Grooved Dark Cocoa | PRGV5412DC | PRGV5416DC | PRGV5420DC |
| 1 x 6 Square Shoulder Dark Cocoa | — | PR5416DC | PR5420DC |
| PRIME+ FASCIA | | | |
| 12" Fascia Coconut Husk | FBE12CH | — | — |
| 12" Fascia Sea Salt Gray | FBE12ST | — | — |
| 12" Fascia Dark Cocoa | FBE12DC | — | — |
| PRIME+ RISER | | | |
| 7-1/4" Riser Coconut Husk | ERISERCH | — | — |
| 7-1/4" Riser Sea Salt Gray | ERISERST | — | — |
| 7-1/4" Riser Dark Cocoa | ERISERDC | — | — |

Profile Options

STANDARD

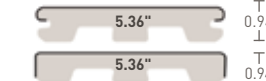

RISER

FASCIA



TIMBERTECH® SPECIALTY DECKING

Known for long-term durability and low-maintenance nature, the specialty boards combine the look and feel of natural wood at a price that's just a step above traditional lumber. Each board features a slip-resistant, splinter-free wood grain texture. Plus, the 4-sided protective shell provides additional protection from the elements.

Photo: ReliaBoard Cedar



ReliaBoard®

A step up from traditional lumber, ReliaBoard demands attention for all the right reasons. Boasting a classic cathedral wood grain pattern and the look of painted wood, this decking is a practical and affordable option for homeowners looking to ditch the costly maintenance of traditional wood decking. These beautiful boards are covered by a 4-sided, protective and low-maintenance shell.



| PRODUCT DESCRIPTION | TimberTech Model Number | | |
|------------------------------|-------------------------|---------|---------|
| | 12' | 16' | 20' |
| RELIABOARD | | | |
| 1 x 6 Square Shoulder Cedar | RB5412C | RB5416C | RB5420C |
| 1 x 6 Square Shoulder Gray | RB5412G | RB5416G | RB5420G |
| FASCIA | | | |
| 12" TwinFascia Board Cedar | FBVG12C | — | — |
| 12" TwinFascia Board Gray | FBVG12G | — | — |
| RISER | | | |
| 7-1/4" TwinRiser Board Cedar | FBRISERC | — | — |
| 7-1/4" TwinRiser Board Gray | FBRISERG | — | — |

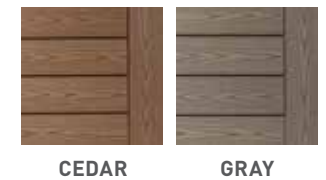

Profile Options



PRO-Tac™ Flashing and Joist Tape

- A heavy duty, flexible, all weather tape to extend the life of decking substructures
- The butyl adhesive provides an advanced, secure bond to joists that won't peel off
- Can be used in all weather conditions; rated for use in temperatures from -70°F to 200°F

| PRODUCT DESCRIPTION | TimberTech Model Number | |
|---------------------------|-------------------------|--------------|
| | 25' | 65' |
| PRO-TAC TAPE | | |
| 1.625" Pro-Tac Joist Tape | — | PTCS1625X65B |
| 2.5" Pro-Tac Joist Tape | — | PTCS25X65B |
| 3.25" Pro-Tac Joist Tape | — | PTCS325X65B |
| 4" Pro-Tac Joist Tape | — | PTCS4X65B |
| 12" Pro-Tac Joist Tape | PTCS12X25B | — |



Non-toxic, bleach-free, and biodegradable

TimberTech DeckCleaner™

- Cleans decking, railing, trim, and moulding
- Concentrated formula that removes dirt, mold, mildew, dust, pollen, and more
- Cleans approximately 1,000 square feet of surface area when properly diluted
- Guaranteed not to damage TimberTech products, or affect the warranty, when used as directed on the recommended products
- Not intended for wood or traditional composite decking (non-capped)

| PRODUCT DESCRIPTION | TimberTech Model Number |
|----------------------------------|-------------------------|
| TIMBERTECH DECKCLEANER | |
| 1 Gallon DeckCleaner (case of 4) | TTCLNCASE1G |

| PRODUCT | BRUSH TYPE & RECOMMENDATION |
|--|---|
| AZEK Decking and Porch | A stiff natural fiber brush |
| PRO Decking, EDGE Decking, Specialty Decking | Medium to stiff nylon brush Quickie Bulldozer Poly Fiber Deck Brush |

TIMBERTECH® FASTENERS

Opt for the best fastening systems to install your deck. These high-quality fasteners give decks added strength and integrity for years to come.



Photo: TOPLoc® for AZEK® Color-matched stainless steel decking fasteners on Mahogany decking

TOPLoc® for AZEK®

Color-matched, stainless steel decking fasteners.

FOR USE WITH ALL TIMBERTECH AZEK® DECK BOARDS



- Head painted to complement AZEK Decking colors
- 305 grade stainless steel screws ACQ approved, with a TORX® ttap® drive system for a wobble-free installation
- Compatible with all TimberTech AZEK deck boards

| PRODUCT DESCRIPTION | TimberTech Model Number | |
|-----------------------------------|-------------------------|------------|
| | 100 SQ FT | 300 SQ FT |
| TOPLOC FOR TIMBERTECH AZEK | | |
| 2½" TOPLoc Screws Brown | ATLOC100B | ATLOC300B |
| 2½" TOPLoc Screws Dark Brown | ATLOC100DB | ATLOC300DB |
| 2½" TOPLoc Screws Light Tan | ATLOC100LT | ATLOC300LT |
| 2½" TOPLoc Screws Light Gray | ATLOC100LG | ATLOC300LG |
| 2½" TOPLoc Screws Dark Gray | ATLOC100DG | ATLOC300DG |

TOPLoc® Fascia for AZEK®

Color-matched stainless steel fastener designed for fascia boards.

FOR USE WITH ALL AZEK® COLLECTIONS FASCIA BOARDS



- Head painted to complement AZEK Fascia colors
- 305 grade stainless steel screws ACQ approved, with a TORX® ttap® drive system for a wobble-free installation
- Compatible with fascia boards from the TimberTech AZEK line

| PRODUCT DESCRIPTION | TimberTech Model Number | |
|---|-------------------------|--|
| | 30 LIN FT | |
| TOPLOC FASCIA FOR AZEK | | |
| 1⅝" TOPLoc Fascia Screws Brown 100/Pkg | ATLOCFAS30B | |
| 1⅝" TOPLoc Fascia Screws Dark Brown 100/Pkg | ATLOCFAS30DB | |
| 1⅝" TOPLoc Fascia Screws Light Tan 100/Pkg | ATLOCFAS30LT | |
| 1⅝" TOPLoc Fascia Screws Light Gray 100/Pkg | ATLOCFAS30LG | |
| 1⅝" TOPLoc Fascia Screws Dark Gray 100/Pkg | ATLOCFAS30DG | |

Colors:
TOPLoc for TimberTech AZEK Decking & Fascia

Brown: Mahogany, English Walnut®
Dark Brown: Kona®, Dark Hickory, American Walnut™
Light Gray: Slate Gray, Coastline®

Dark Gray: Castle Gate™
Light Tan: Weathered Teak™, French White Oak®, Brownstone
Tan: Cypress

TOPLoc® for PRO® & EDGE®

Top-down, color-matched, carbon steel or stainless steel deck fasteners.

USE WITH ALL TIMBERTECH PRO® AND TIMBERTECH EDGE™ DECK BOARDS



- Choose from color-matched fasteners available in high-quality, coated carbon steel or stainless steel screws in select colors
- Designed for dense composite material using an 18v drill set at high speed for maximum performance
- Compatible with all TimberTech PRO and EDGE deck boards

| PRODUCT DESCRIPTION | TimberTech Model Number | | |
|--|-------------------------|-----------|------------|
| | 85 SQ FT | 100 SQ FT | 500 SQ FT |
| TOPLOC FOR TIMBERTECH PRO & TIMBERTECH EDGE | | | |
| 2½" TOPLoc Screws Ivory | — | TLOC350I | TLOC1750I |
| 2½" TOPLoc Screws Cedar | — | TLOC350C | TLOC1750C |
| 2½" TOPLoc Screws Teak | — | TLOC350T | TLOC1750T |
| 2½" TOPLoc Screws Walnut | — | TLOC350W | TLOC1750W |
| 2½" TOPLoc Screws Light Gray | — | TLOC350LG | TLOC1750LG |
| 2½" TOPLoc Screws Gray | — | TLOC350G | TLOC1750G |
| 2½" TOPLoc Screws Dark Gray | — | TLOC350DG | TLOC1750DG |
| 3" TOPLoc SS Screws Ivory | TLOC300SSI | — | — |
| 3" TOPLoc SS Screws Cedar | TLOC300SSC | — | — |
| 3" TOPLoc SS Screws Teak | TLOC300SST | — | — |
| 3" TOPLoc SS Screws Walnut | TLOC300SSW | — | — |
| 3" TOPLoc SS Screws Light Gray | TLOC300SSLG | — | — |
| 3" TOPLoc SS Screws Gray | TLOC300SSG | — | — |
| 3" TOPLoc SS Screws Dark Gray | TLOC300SSDG | — | — |

TOPLoc® Fascia for PRO® & EDGE®

Color-matched, stainless steel decking fasteners.

USE WITH ALL TIMBERTECH PRO® AND TIMBERTECH EDGE™ FASCIA BOARDS



- Color-matched stainless steel screw designed to decrease oil-canning
- Compatible with fascia boards from the TimberTech PRO and TimberTech EDGE lines

| PRODUCT DESCRIPTION | TimberTech Model Number | |
|---|-------------------------|--|
| | 30 LIN FT | |
| TOPLOC FASCIA FOR TIMBERTECH PRO & TIMBERTECH EDGE | | |
| 1¾" TOPLoc Fascia Screws Ivory 100/Pkg | TLOCFAS100I | |
| 1¾" TOPLoc Fascia Screws Cedar 100/Pkg | TLOCFAS100C | |
| 1¾" TOPLoc Fascia Screws Teak 100/Pkg | TLOCFAS100T | |
| 1¾" TOPLoc Fascia Screws Walnut 100/Pkg | TLOCFAS100W | |
| 1¾" TOPLoc Fascia Screws Light Gray 100/Pkg | TLOCFAS100LG | |
| 1¾" TOPLoc Fascia Screws Gray 100/Pkg | TLOCFAS100G | |
| 1¾" TOPLoc Fascia Screws Dark Gray 100/Pkg | TLOCFAS100DG | |
| TOPLoc Fascia Drill Bit | TLOCFASBIT | |

Colors:
TOPLoc for TimberTech PRO and EDGE Decking & Fascia

Light Gray: Stone Ash®, Sea Salt Gray
Gray: Maritime Gray™, Driftwood, Gray*
Dark Gray: Silver Maple, Ashwood, Espresso™
Teak: Antique Leather™, Pecan, Tigerwood, Coconut Husk™

Walnut: Brown Oak, Rustic Elm®, Dark Roast™, Mocha, Dark Cocoa
Ivory: Whitewash Cedar®
Cedar: Cedar*
Sand: Sandy Birch

*Color-matched to ReliaBoard®

FUSIONLoc®

Stainless steel clip provides a secure board-to-joist connection with a hidden appearance.

USE WITH ALL TIMBERTECH GROOVED DECK BOARDS



- Collated hidden fastener system engineered for strength and speed
- Offers a pneumatic installation with the FastenMaster FiveShot Tool or manual installation using the FUSIONLoc Hand Driven Guide
- Compatible with all TimberTech grooved deck boards

| PRODUCT DESCRIPTION | TimberTech Model Number |
|--|-------------------------|
| FUSIONLOC FOR AZEK, PRO, & EDGE | |
| FUSIONLoc 225 SF/Pkg (Pneumatic) | FLOC225 |
| FUSIONLoc 450 SF/Pkg (Pneumatic) | FLOC450 |
| FUSIONLoc Hand Driven Guide | FLOCHDGUIDE |
| FUSIONLoc 50 SF/Pkg (Hand Driven) | FLOCHD50 |
| FUSIONLoc 225 SF/Pkg (Hand Driven) | FLOCHD225 |

CONCEALoc®

Screws and clips with a matte brown finish for a hidden appearance.

USE WITH ALL TIMBERTECH GROOVED DECK BOARDS



- Hidden fastener system that can be installed pneumatically with the FastenMaster Tiger Claw Gun or using a drill
- Stainless steel clips for long-term performance
- Compatible with all TimberTech grooved deck boards

| PRODUCT DESCRIPTION | TimberTech Model Number |
|--|-------------------------|
| CONCEALOC FOR AZEK, PRO, & EDGE | |
| CONCEALoc 100 SF/Cartron Clips and Screws | CLOCFAST |
| CONCEALoc 500 SF/Pkg Gun Pail Clips and Screws for Pneumatic | CLOGUNPAIL |
| CONCEALoc 1000 SF/Bucket Clips and Screws | CLOCBULK |
| CONCEALoc L-Bracket 50/Pk Brackets and Screws | CLOCLBKT |
| CONCEALoc Router Bit | CLOCRBIT |
| CONCEALoc Replacement Screws, 50 Screws | CLOCSCREW |

SIDELoc™

Use SIDELoc guide to drive stainless steel screws to the perfect depth creating an 1/8" board spacing.

USE WITH TIMBERTECH® AZEK® SQUARE SHOULDERED DECK BOARDS



- Hidden fastener system with superior holding power that requires no pre-drilling
- Stainless steel to resist screw shear and installs creating a perfect 1/8" gap
- Compatible with all TimberTech AZEK square shouldered deck boards

| PRODUCT DESCRIPTION | TimberTech Model Number | | |
|---|-------------------------|----------------|----------------|
| | 100 SQ FT | 200 SQ FT | 500 SQ FT |
| SIDELOC FOR AZEK | | | |
| 1 1/8" SIDELoc 304 Stainless Steel Screws | SLOC100SF188 | SLOC200SF188 | SLOC500SF188 |
| 2 3/8" SIDELoc 316 Marine Grade SS Screws | SLOC100SF238MG | SLOC200SF238MG | SLOC500SF238MG |

| TOOLS AND ACCESSORIES | TimberTech Model Number |
|---|-------------------------|
| SIDELoc 3" Driver Bits (set of 2) | SLOCBIT |
| SIDELoc 5 1/2" Guide for standard width AZEK Deck | SLOCGUIDE |
| SIDELoc 3 1/2" Guide for narrow width AZEK Deck | SLOC350GUIDE |
| SIDELoc 7 1/4" Extension for wide width AZEK Deck | SLOC725EXT |

EDGELoc™ for EDGE®

Nylon 12-clip collated strip & pre-set stainless steel screws provide a consistent 7/32" gap

USE WITH TIMBERTECH EDGE GROOVED DECK BOARDS



- Hidden fastener system that is easy to use
- 12-clip collated strip reduces installation time
- Compatible with all TimberTech EDGE Grooved deck boards

| PRODUCT DESCRIPTION | TimberTech Model Number | |
|--------------------------|-------------------------|-----------|
| | 55 SQ FT | 250 SQ FT |
| CORTEX FOR AZEK | | |
| EDGELoc Hidden Fasteners | ELOC55 | ELOC250 |

Cortex® for AZEK®

Top-down fastener with color-matched plugs made from TimberTech deck boards for the ultimate fastener-free surface.

USE WITH ALL FULL PROFILE TIMBERTECH DECK BOARDS



- A top-down hidden fastener system that features a high-quality, ACQ approved, specialty deck screw with a Torx® tTap® drive system
- Color-matched plugs made from TimberTech decking to hide the fastener (excluding scalloped Terrain, Prime+ Collections, and ReliaBoard®)
- Compatible with all TimberTech full profile deck boards

| PRODUCT DESCRIPTION | TimberTech Model Number | | | |
|---------------------------------------|-------------------------|----------------|-----------------|-----------------|
| | 100 SQ FT | 300 SQ FT | 100 SF COLLATED | 300 SF COLLATED |
| CORTEX FOR AZEK | | | | |
| Cortex Screws - Brownstone | CTX100SFBS | CTX300SFBS | CTC100SFBS | CTC300SFBS |
| Cortex Screws - Kona | CTX100SFKO | CTX300HCKOAAAT | CTC100SFKO | CTC300SFKO |
| Cortex Screws - Slate Gray | CTX100SFSG | CTX300SFSG | CTC100SFSG | CTC300SFSG |
| NEW! Cortex Screws - American Walnut | | | CTC100SFAW | CTC300SFAW |
| NEW! Cortex Screws - Castle Gate | | | CTC100SFCG | CTC300SFCG |
| Cortex Screws - Coastline | CTX100SFCS | CTX300SFCS | CTC100SFCS | CTC300SFCS |
| Cortex Screws - Dark Hickory | CTX100SFDH | CTX300SFDH | CTC100SFDH | CTC300SFDH |
| Cortex Screws - English Walnut | CTX100SFEW | CTX300SFEW | CTC100SFEW | CTC300SFEW |
| Cortex Screws - Mahogany | CTX100SFMH | CTX300SFMH | CTC100SFMH | CTC300SFMH |
| Cortex Screws - Weathered Teak | CTX100SFWT | CTX300SFWT | CTC100SFWT | CTC300SFWT |
| CORTEX FOR AZEK MAX | | | | |
| Cortex Screws - Slate Gray - AZEK MAX | | | CTCM100SFSG | |
| Cortex Screws - Coastline - AZEK MAX | | | CTCM100SFCS | |

Cortex® for PRO® & EDGE™

Top-down fastener with color-matched plugs made from TimberTech deck boards for the ultimate fastener-free surface.

USE WITH ALL FULL PROFILE TIMBERTECH® PRO® AND TIMBERTECH® EDGE® DECK BOARDS



| PRODUCT DESCRIPTION | TimberTech Model Number |
|----------------------------------|-------------------------|
| CORTEX FOR PRO & EDGE | |
| Cortex Screws - Dark Teak | CTX100EDT |
| Cortex Screws - Maritime Gray | CTX100EMG |
| Cortex Screws - Ashwood | CTX100LCAW |
| Cortex Screws - Espresso | CTX100LCE |
| Cortex Screws - Mocha | CTX100LCM |
| Cortex Screws - Pecan | CTX100LCP |
| Cortex Screws - Tigerwood | CTX100LCTW |
| Cortex Screws - Whitewash Cedar | CTX100LWCW |
| Cortex Screws - Antique Leather | CTX100RCAL |
| Cortex Screws - Dark Roast | CTX100RCDR |
| Cortex Screws - Driftwood | CTX100RCDW |



TIMBERTECH® COMPOSITE RAILING

Our most popular collection has rightly been dubbed the "Designer Series" of railing. Boasting multiple top rail and infill choices, this simple system gives you endless design options to make your outdoor living space truly yours. Take your home's outdoor space to the next level with its bold details and variety of colors with this railing series.



Photo: Classic Composite Series with Trademark Top Rail in White

Classic Composite Series

BOLD. BEAUTIFUL. REFINED.

5 top rail options | 3 Color options | 4 infill options



DRINK RAIL

Choose a deck board to complement your decking*

RADIANCE RAIL®



TRADEMARK RAIL™

Only Available in White and Matte White

PREMIER RAILING®

Color Options



Fade & Stain Warranty applies to matte white only

Infill Options



CABLERAIL

GLASS

*The Drink Rail system works with all full profile, square shouldered deck boards, but NOT with scalloped boards (i.e. Terrain, Prime, Prime+ or ReliaBoard).



CONTEMPORARY RAIL

Contemporary Top Rail only available in the following colors



TRADITIONAL WALNUT**

CLASSIC BLACK**

**Classic Black or Traditional Walnut colors available for Top Rail only. Please note that these colors are different from the five Classic Composite colors and will not be an exact match.



Classic Composite Series Kits, Packs, and Top Rails

| PRODUCT DESCRIPTION | TimberTech Model Number | | |
|---|-------------------------|---------------|----------------|
| | WHITE | BLACK | MATTE WHITE |
| UNIVERSAL RAIL KITS - Kits include 1 Universal Rail, 2 Support Rails, Hardware, Footblocks, and 13 Balusters for 6', 18 Balusters for 8' | | | |
| 6' Universal Rail Kit | TCU36KIT6W | — | TCU36KIT6MW |
| 8' Universal Rail Kit | TCU36KIT8W | — | TCU36KIT8MW |
| UNIVERSAL RAIL PACKS - Packs include 1 Universal Rail, 2 Support Rails, Hardware, and Footblocks | | | |
| 6' Universal Rail Pack | TCURP6W | TCURP6B | TCURP6MW |
| 8' Universal Rail Pack | TCURP8W | TCURP8B | TCURP8MW |
| 10' Universal Rail Pack | TCURP10W | TCURP10B | TCURP10MW |
| 6' Custom Universal Rail Pack - Laser Etched | TCURPCUST6W | TCURPCUST6B | TCURPCUST6MW |
| 8' Custom Universal Rail Pack - Laser Etched | TCURPCUST8W | TCURPCUST8B | TCURPCUST8MW |
| 10' Custom Universal Rail Pack - Laser Etched | TCURPCUST10W | TCURPCUST10B | TCURPCUST10MW |
| PREMIER TOP RAIL | | | |
| 6' Premier Top Rail | APTR6W | APTR6B | APTR6MW |
| 8' Premier Top Rail | APTR8W | APTR8B | APTR8MW |
| 10' Premier Top Rail | APTR10W | APTR10B | APTR10MW |
| RADIANCE RAIL TOP RAIL | | | |
| 6' RadianceRail Top Rail | TRRTR06W | TRRTR06B | TRRTR06MW |
| 8' RadianceRail Top Rail | TRRTR08W | TRRTR08B | TRRTR08MW |
| 10' RadianceRail Top Rail | TRRTR10W | TRRTR10B | TRRTR10MW |
| TRADEMARK TOP RAIL | | | |
| 6' Trademark Top Rail | ATTR6W | — | ATTR6MW |
| 8' Trademark Top Rail | ATTR8W | — | ATTR8MW |
| 10' Trademark Top Rail | ATTR10W | — | ATTR10MW |
| DRINK RAIL (UNIVERSAL RAIL) - Includes Undrilled Rail and Hardware to attach deck board | | | |
| 6' Universal Rail | UDCUSTCUBR6W | UDCUSTCUBR6B | UDCUSTCUBR6MW |
| 8' Universal Rail | UDCUSTCUBR8W | UDCUSTCUBR8B | UDCUSTCUBR8MW |
| 10' Universal Rail | UDCUSTCUBR10W | UDCUSTCUBR10B | UDCUSTCUBR10MW |

| PRODUCT DESCRIPTION | TimberTech Model Number | | |
|---|-------------------------|-------|-------------|
| | WHITE | BLACK | MATTE WHITE |
| CLASSIC COMPOSITE SERIES HARDWARE KITS | | | |
| Universal Hardware Kit | AZTHWKITRT | | |
| 8' Baluster Fastener Kit | AZTFAST8 | | |

| PRODUCT DESCRIPTION | TimberTech Model Number | |
|------------------------------|-------------------------|--------------------|
| | CLASSIC BLACK | TRADITIONAL WALNUT |
| CONTEMPORARY TOP RAIL | | |
| 16' Contemporary Top Rail | EVRC16CB | EVRC16TW |

Classic Composite Infills

| PRODUCT DESCRIPTION | TimberTech Model Number | | |
|--------------------------------------|-------------------------|-----------|-------------|
| | WHITE | BLACK | MATTE WHITE |
| COMPOSITE BALUSTERS - 18/Pack | | | |
| 29" Square Composite Balusters | AZT29BALW | AZT29BALB | AZT29BALMW |
| 31" Square Composite Balusters | AZT31BALW | AZT31BALB | AZT31BALMW |
| 35" Square Composite Balusters | AZT35BALW | AZT35BALB | AZT35BALMW |
| 37" Square Composite Balusters | AZT37BALW | AZT37BALB | AZT37BALMW |

| PRODUCT DESCRIPTION | TimberTech Model Number | | | |
|-------------------------------------|-------------------------|----------------------|-----------------|-----------------------|
| | ROUND ALUMINUM | ROUND STAIR ALUMINUM | SQUARE ALUMINUM | SQUARE STAIR ALUMINUM |
| ALUMINUM BALUSTERS - 20/Pack | | | | |
| 29" Use with 36" Rail | AZT29RABALB | — | AZT29SABALB | — |
| 31" Use with 36" Rail | AZT31RABALB | AZT31RASTAIRBALB | AZT31SABALB | AZT31SASTAIRBALB |
| 35" Use with 42" Rail | AZT35RABALB | — | AZT35SABALB | — |
| 37" Use with 42" Rail | AZT37RABALB | AZT37RASTAIRBALB | AZT37SABALB | AZT37SASTAIRBALB |

Required number of Balusters for Composite: 23 per 10' section, 18 per 8' section, 13 per 6' section.

Required number of Balusters for Aluminum: 25 per 10' section, 20 per 8' section, 15 per 6' section.

Classic Composite Infills(Continued)

| PRODUCT DESCRIPTION | TimberTech Model Number | | |
|--|-------------------------|-------|-------------|
| | WHITE | BLACK | MATTE WHITE |
| CABLERRAIL KITS | | | |
| 36" CableRail Hardware Kit - 9 Quick-Connect fittings, 9 Quick-Connect swivel fittings, 18 Hanger Bolts, 9 Lock Nuts | AZTCR36HWKIT | | |
| 42" CableRail Hardware Kit - 11 Quick-Connect fittings, 11 Quick-Connect swivel fittings, 22 Hanger Bolts, 11 Lock Nuts | AZTCR42HWKIT | | |
| 36" CableRail Intermediate Baluster - 9-Hole Baluster, Intermediate Base Plate, #10X2" Pan Head Screw, (3) #10X1" Flat Head Screws | AZTCR36BAL | | |
| 42" CableRail Intermediate Baluster - 11-Hole Baluster, Intermediate Base Plate, #10X2" Pan Head Screw, (3) #10X1" Flat Head Screws | AZTCR42BAL | | |
| 36" CableRail Stair Intermediate Baluster - Angled 9-Hole Baluster, Intermediate Base Plate, #10X2" Pan Head Screw, (3) #10X1" Flat Head Screws | AZTCR36STAIRBAL | | |
| 42" CableRail Stair Intermediate Baluster - Angled 11-Hole Baluster, Intermediate Base Plate, #10X2" Pan Head Screw, (3) #10X1" Flat Head Screws | AZTCR42STAIRBAL | | |
| CableRail 100' Stainless Steel Cable | AZTCR100CABLE | | |
| CableRail 500' Stainless Steel Cable | AZTCR500CABLE | | |
| CableRail Accessory Kit | AZTCRACKKIT | | |
| CableRail Cutter | AZTCRCUTTER | | |
| CableRail Protector Sleeves (20/Pg) | AZTCRSLEEVE | | |
| CableRail SteelRenewal™ SteelProtect™ Combo | AZTCRSRSPC | | |
| GLASS CHANNEL KITS | | | |
| 6' Glass Channel Kit White - Glass Panel Sourced Locally | AZTGLASS6W | | |
| 6' Glass Channel Kit Black - Glass Panel Sourced Locally | AZTGLASS6B | | |

Classic Composite Post Sleeves, Caps, Skirts

| PRODUCT DESCRIPTION | TimberTech Model Number | | |
|--------------------------------|-------------------------|---------------|----------------|
| | WHITE | BLACK | MATTE WHITE |
| POST SLEEVES | | | |
| 4" x 4" x 39" Post Sleeve | AZT4X4PCV39W | AZT4X4PCV39B | AZT4X4PCV39MW |
| 4" x 4" x 96" Post Sleeve | AZT4X4PCV96W | AZT4X4PCV96B | AZT4X4PCV96MW |
| 5" x 5" x 42" Post Sleeve | T5X5PCV42W | T5X5PCV42B | T5X5PCV42MW |
| 5" x 5" x 144" Post Sleeve | T5X5PCV144W | T5X5PCV144B | T5X5PCV144MW |
| 5.5" x 5.5" x 39" Post Sleeve | A55X55PCV39W | A55X55PCV39B | A55X55PCV39MW |
| 5.5" x 5.5" x 54" Post Sleeve | A55X55PCV54W | A55X55PCV54B | A55X55PCV54MW |
| 5.5" x 5.5" x 144" Post Sleeve | A55X55PCV144W | A55X55PCV144B | A55X55PCV144MW |
| POST CAPS AND SKIRTS | | | |
| 4" x 4" Post Cap | TX4X4PCAPW | TX4X4PCAPB | TX4X4PCAPMW |
| 4" x 4" Island Cap | TX4X4ICAPW | TX4X4ICAPB | TX4X4ICAPMW |
| 4" x 4" Post Skirt | AZT4X4PSKIRTW | AZT4X4PSKIRTB | AZT4X4PSKIRTMW |
| 5" x 5" Post Cap | T5X5PCAPW | T5X5PCAPB | T5X5PCAPMW |
| 5" x 5" Post Skirt | T5X5PSKIRTW | T5X5PSKIRTB | T5X5PSKIRTMW |
| 5.5" x 5.5" Pyramid Cap | A55X55PCAPW | A55X55PCAPB | A55X55PCAPMW |
| 5.5" x 5.5" Island Cap | A55X55ICAPW | A55X55ICAPB | A55X55ICAPMW |
| 5.5" x 5.5" Post Skirt | A55X55PSKIRTW | A55X55PSKIRTB | A55X55PSKIRTMW |

A 5.5"x5.5" post sleeve is required for applications with 45° or other angled cuts.

Classic Composite Support Rails

| PRODUCT DESCRIPTION | TimberTech Model Number | |
|--|-------------------------|-----------------|
| | WHITE | BLACK |
| CUSTOM SUPPORT RAILS - Laser-Etched for Aluminum Balusters | | |
| 8' Custom Support Rails | AZTBULKSR8W | AZTBULKSR8B |
| CUSTOM SUPPORT RAILS - Blank for 10' Bottom Support Rails | | |
| 10' Custom Support Rails | AZTBULKUDSR10W | AZTBULKUDSR10B |
| ALUMINUM SUPPORT RAILS - Drilled for Composite Balusters | | |
| 10' Aluminum Support Rails | AZTBULKSR10W | AZTBULKSR10B |
| CUSTOM ALUMINUM SUPPORT RAILS - Marked for Aluminum Balusters | | |
| 10' Custom Aluminum Support Rails | AZTBULKUSTSR10W | AZTBULKUSTSR10B |

Composite Railing

How to Order:

1 Select preferred style and color

2 Select preferred infill

3 Select post sleeve and finishing touches — caps, skirts, lighting

1. STYLES AND COLORS

Classic Composite Series



Premier Railing®
3.5"W x 2.7"H



RadianceRail®
2.9"W x 2.9"H



Trademark Rail™
3.5"W x 2.7"H
Only available in White



Drink Rail
Compatible with full profile, square-shoulder boards
• TimberTech AZEK Boards 5.5"W x 1"H
• TimberTech PRO & EDGE Premier Collection Boards 5.36"W x .94"H

Color Options



WHITE BLACK



MATTE WHITE

Fade & Stain Warranty applies to matte white only



Contemporary Rail
6.4"W x 3"H
Only available in Classic Black and Traditional Walnut



TRADITIONAL WALNUT CLASSIC BLACK

2. INFILLS

1.25" x 1.25" Composite

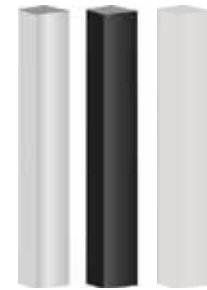

.75" x .75" Aluminum Round and Square Black Only



Glass Channel to fit 1/4" Tempered Glass



CableRail

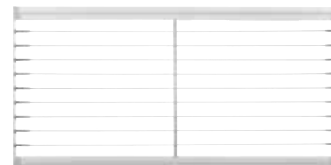

Available in 4" x 4" 5" x 5" 5.5" x 5.5"



3. POSTS SLEEVES

3. CAPS AND SKIRTS

4" x 4" Cap 5.63" x 5.63" Profile



4" x 4" Island Cap 7.1" x 7.1" Profile



5" x 5" Cap 7.11" x 7.11" Profile



5.5" x 5.5" Island Cap 8.32" x 8.32" Profile



5.5" x 5.5" Pyramid Cap 8.32" x 8.32" Profile



4" x 4" Skirt 5.42" x 5.42" Profile



5" x 5" Skirt 6.36" x 6.36" Profile



5.5" x 5.5" Skirt 8.0" x 8.0" Profile



4" x 4" Skirt 5.42" x 5.42" Profile



5" x 5" Skirt 6.36" x 6.36" Profile



5.5" x 5.5" Skirt 8.0" x 8.0" Profile



3. LIGHTING

5.5" x 5.5" Lighted Island Cap 8.32" x 8.32" Profile



4" x 4", 5" x 5", 5.5" x 5.5" Post Cap Light



Accent Lights (Available in white or architectural bronze)



Under Rail Lights



Accent Lights (Available in white or architectural bronze)



RadianceRail Express®

SIMPLE. SCULPTED. TIMELESS.



Rail Packs are available in different lengths for level and stair applications with baluster options to accommodate a 36" or 42" railing height. RadianceRail Express pairs with the 4" x 4" Post Sleeve.

RadianceRail Express gaskets are included the level Rail Packs, and RadianceRail Express hardware is included in all Rail Packs. Hardware and gaskets are also offered separately for installing two shorter sections while using one Rail Pack and for replacements.

Builder Rail

BOLD. MODERN. IMPACTFUL.



For a top rail, select standard width, full profile, square-shoulder deck boards.

| PRODUCT DESCRIPTION | TimberTech Model Number | | |
|---|-------------------------|----------------|----------------|
| | WHITE | BLACK | KONA |
| RADIANCE RAIL EXPRESS SMART SETS - Includes Top & Bottom Rail, 4x4 Post Sleeve, 4" Post Cap, 4" Post Skirt, Hardware, Footblocks, 13 Balusters for 6', 18 Balusters for 8' | | | |
| 6' RadianceRail Express Smart Set | TXSS6W | — | — |
| 6' RadianceRail Express Stair Smart Set | TXSSS6W | — | — |
| 8' RadianceRail Express Smart Set | TXSS8W | — | — |
| 8' RadianceRail Express Stair Smart Set | TXSSS8W | — | — |
| RADIANCE RAIL EXPRESS PACKS Packs include Top & Bottom Rail, Hardware, Gaskets, and Footblocks | | | |
| 6' RadianceRail Express Pack | TXRP6W | TXRP6B | TXRP6K |
| 8' RadianceRail Express Pack | TXRP8W | TXRP8B | TXRP8K |
| RADIANCE RAIL EXPRESS STAIR PACKS Packs include Top & Bottom Rail, Hardware, and Footblocks | | | |
| 8' RadianceRail Express Stair Pack | TXSRP8W | TXSRP8B | TXSRP8K |
| RADIANCE RAIL EXPRESS ROUND ALUMINUM BALUSTER (RAB) RAIL PACKS Packs include Top & Bottom Rail, Hardware and Footblocks | | | |
| 6' RadianceRail Express RAB Pack | TXRPAB6W | TXRPAB6B | TXRPAB6K |
| 8' RadianceRail Express RAB Pack | TXRPAB8W | TXRPAB8B | TXRPAB8K |
| RADIANCE RAIL EXPRESS ROUND ALUMINUM BALUSTER (RAB) STAIR PACKS Packs include Top & Bottom Rail, Hardware, and Footblocks | | | |
| 8' RadianceRail Express RAB Stair Pack | TXSRPRAB8W | TXSRPRAB8B | TXSRPRAB8K |
| RADIANCE RAIL EXPRESS COMPOSITE BALUSTERS - 18/Pack | | | |
| 29.75" Square Composite Baluster | TX30BALW | TX30BALB | TX30BALK |
| 35.75" Square Composite Baluster | TX36BALW | TX36BALB | TX36BALK |
| RADIANCE RAIL ROUND ALUMINUM BALUSTERS - 18/Pack | | | |
| 29" Round Aluminum Balusters | — | TX30RABALB | — |
| 35" Round Aluminum Balusters | — | TX36RABALB | — |
| RADIANCE RAIL EXPRESS POST SLEEVES | | | |
| 4" x 4" x 39" Post Sleeve | AZT4X4PCV39W | AZT4X4PCV39B | AZT4X4PCV39K |
| 4" x 4" x 96" Post Sleeve | AZT4X4PCV96W | AZT4X4PCV96B | AZT4X4PCV96K |
| RADIANCE RAIL EXPRESS POST CAPS AND SKIRTS | | | |
| 4" x 4" Post Cap | TX4X4PCAPW | TX4X4PCAPB | TX4X4PCAPK |
| 4" x 4" Island Cap | TX4X4ICAPW | TX4X4ICAPB | TX4X4ICAPK |
| 4" x 4" Post Skirt | AZT4X4PSKIRTW | AZT4X4PSKIRTB | AZT4X4PSKIRTK |
| RADIANCE RAIL EXPRESS HARDWARE KITS | | | |
| Mounting Kit | TXBTKITW | TXBTKITB | TXBTKITK |
| Mounting Kit for Stairs | TXBKTSTAIRKITW | TXBKTSTAIRKITB | TXBKTSTAIRKITK |
| Gasket Pack Kit - Includes 4 gaskets (for level applications only) | TXGSTPKW | TXGSTPKB | TXGSTPKK |

Required number of composite balusters for level applications: 18 per 8' section, 13 per 6' section.
 Required number of composite balusters for stairs: 14 per 8' section, 11 per 6' section.
 Required number of round aluminum balusters for level applications: 20 per 8' section, 15 per 6' section.
 Required number of round aluminum balusters for stairs: 20 per 8' section, 15 per 6' section.
 *Additional Post Sleeves, Post Caps, and Post Skirts may be purchased separately if needed.

| PRODUCT DESCRIPTION | TimberTech Model Number | |
|---|-------------------------|--------------------|
| | CLASSIC BLACK | TRADITIONAL WALNUT |
| BUILDER RAIL BOARD - Packaged as (2) 6' boards | | |
| 6' 2x4 Builder Rail Board | BB2406CB | BB2406TW |
| 8' 2x4 Builder Rail Board | BB2408CB | BB2408TW |
| BUILDER RAIL HARDWARE KITS - Used for Level and Stair Applications | | |
| Mounting Kit | EVHWKITCB | EVHWKITTW |
| BUILDER RAIL POST SLEEVES | | |
| 42" Builder Rail 5"x5" Post Sleeves | EV5X5PCV42CB | EV5X5PCV42TW |
| 8' Builder Rail 5"x5" Post Sleeves | EV5X5PCV8CB | EV5X5PCV8TW |
| BUILDER RAIL POST SKIRTS | | |
| Builder Rail 5"x5" Post Skirt | EV5X5PSKIRTW | EV5X5PSKIRTTW |
| BUILDER RAIL FOOT BLOCKS | | |
| Builder Rail Foot Block | EVFBCB | EVFBTW |

| PRODUCT DESCRIPTION | TimberTech Model Number | |
|--|-------------------------|--|
| | BLACK | |
| BUILDER RAIL METAL BALUSTERS - 20/Pack | | |
| 36" Round Metal Baluster Pack - 25" Baluster Height | BRMB36KITBCM | |
| 36" Round Metal Baluster Pack - 23.75" Baluster Height | BRMB36STAIRBCM | |
| 42" Round Metal Baluster Pack - 31" Baluster Height | BRMB42KITBCM | |
| 42" Round Metal Baluster Pack - 29.75" Baluster Height | BRMB42STAIRBCM | |

Reserve Rail™

CLASSIC. STATELY. POWERFUL.



Reserve Rail available regionally



| PRODUCT DESCRIPTION | TimberTech Model Number | |
|--|-------------------------|--|
| | WHITE | |
| RESERVE RAIL PACKS - Packs include Bottom Rail, 2 Support Rails, Hardware, and Footblocks (Top Rail sold separately) | | |
| 6' Reserve Rail Pack | ARRP6W | |
| 8' Reserve Rail Pack | ARRP8W | |
| 10' Reserve Rail Pack | ARRP10W | |
| RESERVE CUSTOM RAIL PACKS - Packs include Bottom Rail, 2 Support Rails, Hardware, and Footblocks. For use with custom infill: Glass Channels, CableRail, or Aluminum Balusters (Top Rail sold separately) | | |
| 6' Reserve Rail Custom Pack | ARCUST6W | |
| 8' Reserve Rail Custom Pack | ARCUST8W | |
| 10' Reserve Rail Custom Pack | ARCUST10W | |
| RESERVE RAIL TOP RAIL - Sold separately for safe efficient shipping and over the post installs | | |
| 6' Reserve Top Rail | AR55TR6W | |
| 8' Reserve Top Rail | AR55TR8W | |
| 10' Reserve Top Rail | AR55TR10W | |
| 16' Reserve Top Rail | AR55TR16W | |
| RESERVE RAIL COMPOSITE BALUSTERS - 18/Pack | | |
| 29" Square Composite Baluster | AR29BALW | |
| 31" Square Composite Baluster | AR31BALW | |
| 35" Square Composite Baluster | AR35BALW | |
| 37" Square Composite Baluster | AR37BALW | |

| PRODUCT DESCRIPTION | TimberTech Model Number | | | |
|-------------------------------------|-------------------------|----------------------|-----------------|-----------------------|
| | ROUND ALUMINUM | ROUND STAIR ALUMINUM | SQUARE ALUMINUM | SQUARE STAIR ALUMINUM |
| ALUMINUM BALUSTERS - 20/Pack | | | | |
| 29" Use with 36" Rail | AZT29RABALB | — | AZT29SABALB | — |
| 31" Use with 36" Rail | AZT31RABALB | AZT31RASTAIRBALB | AZT31SABALB | AZT31SASTAIRBALB |
| 35" Use with 42" Rail | AZT35RABALB | — | AZT35SABALB | — |
| 37" Use with 42" Rail | AZT37RABALB | AZT37RASTAIRBALB | AZT37SABALB | AZT37SASTAIRBALB |

| PRODUCT DESCRIPTION | TimberTech Model Number | |
|--|-------------------------|--|
| | WHITE | |
| CABLERRAIL KITS | | |
| 36" CableRail Hardware Kit - 9 Quick-Connect fittings, 9 Quick-Connect swivel fittings, 18 Hanger Bolts, 9 Lock Nuts | AZTCR36HWKIT | |
| 42" CableRail Hardware Kit - 11 Quick-Connect fittings, 11 Quick-Connect swivel fittings, 22 Hanger Bolts, 11 Lock Nuts | AZTCR42HWKIT | |
| 36" CableRail Intermediate Baluster - 9-Hole Baluster, Intermediate Base Plate, #10X2" Pan Head Screw, (3) #10X1" Flat Head Screws | AZTCR36BAL | |
| 42" CableRail Intermediate Baluster - 11-Hole Baluster, Intermediate Base Plate, #10X2" Pan Head Screw, (3) #10X1" Flat Head Screws | AZTCR42BAL | |
| 36" CableRail Stair Intermediate Baluster - Angled 9-Hole Baluster, Intermediate Base Plate, #10X2" Pan Head Screw, (3) #10X1" Flat Head Screws | AZTCR36STAIRBAL | |
| 42" CableRail Stair Intermediate Baluster - Angled 11-Hole Baluster, Intermediate Base Plate, #10X2" Pan Head Screw, (3) #10X1" Flat Head Screws | AZTCR42STAIRBAL | |
| CableRail 100' Stainless Steel Cable | AZTCR100CABLE | |
| CableRail 500' Stainless Steel Cable | AZTCR500CABLE | |
| CableRail Accessory Kit | AZTCRACKKIT | |
| CableRail Cutter | AZTCRCUTTER | |
| CableRail Protector Sleeves (20/Pg) | AZTCRSLEEVE | |
| CableRail Steel Renewal™ SteelProtect™ Combo | AZTCRSRSPC | |
| GLASS CHANNEL KITS | | |
| 6' Glass Channel Kit White - Glass Panel Sourced Locally | AZTGLASS6W | |
| 6' Glass Channel Kit Black - Glass Panel Sourced Locally | AZTGLASS6B | |
| RESERVE RAIL POST SLEEVES | | |
| 4" x 4" x 39" Post Sleeve | AZT4X4PCV39W | |
| 4" x 4" x 96" Post Sleeve | AZT4X4PCV96W | |
| 6" x 6" x 108" Post Sleeve | A6X6PCV108W | |
| RESERVE RAIL POST CAPS AND SKIRTS | | |
| 4" x 4" Post Skirt | AZT4X4PSKIRTW | |
| 6" x 6" Post Cap | A6X6PCAPW | |
| 6" x 6" Post Skirt | A6X6PSKIRTW | |

Reserve Rail is available in Rail Packs only to allow for more customization of colors and infill styles. Post sleeve options include the preferred 6"x6" post sleeve and a 4"x4" post sleeve with a longer top rail for over the post applications. Note: Top rails are sold separately from Rail Packs.

Required number of balusters for composite: 23 per 10' section, 18 per 8' section, 13 per 6' section.
 Required number of balusters for aluminum: 25 per 10' section, 20 per 8' section, 15 per 6' section.

Composite Railing

How to Order:

1 Select preferred style and color

2 Select preferred infill

3 Select post sleeve and finishing touches — caps, skirts, lighting

1. STYLES AND COLORS

Reserve Rail™

5.4"W x 2.7"H

Color Option



WHITE

Reserve Rail styles are available in select markets.



RadianceRail Express®

2.7"W x 2.4"H

Color Options



WHITE



KONA®



BLACK



Builder Rail

5.36"W x 4.34"H

Color Options



CLASSIC BLACK



TRADITIONAL WALNUT

Select square shoulder deck board for Top Rail



2. INFILLS

1.25" x 1.25" Composite



Glass Channel to fit 1/4" Tempered Glass



.75" x .75" Aluminum Round and Square Black Only



CableRail

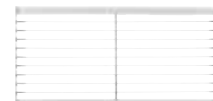

Available in 4" x 4" (for over the post installation) 6" x 6"



1.25" x 1.25" Composite



.75" x .75" Metal Round



Available in 4" x 4"



.75" x .75" Metal Round



Glass Channel to fit 1/4" Tempered Glass



Available in 5" x 5"



3. POSTS SLEEVES

3. CAPS AND SKIRTS

6" x 6" Cap 7.11" x 7.11" Profile



6" x 6" Skirt 9.04" x 9.04" Profile



4" x 4" Skirt 5.42" x 5.42" Profile



4" x 4" Cap 5.63" x 5.63" Profile



4" x 4" Island Cap 7.1" x 7.1" Profile



4" x 4" Skirt 5.42" x 5.42" Profile



5" x 5" Skirt 5.375" x 5.375" Profile



3. LIGHTING

Accent Lights (Available in white, matte white, and architectural bronze)



Under Rail Lights



Accent Lights (Available in white, matte white, and architectural bronze)



4" x 4" Post Cap Light



Accent Lights (Available in white, matte white, and architectural bronze)



TIMBERTECH® METAL RAILING

Keep your sightlines clear and your design lines sleek with these minimalist metal railings. Designed for style and safety, decks with these railings gain an added air of sophistication. Railing is the first thing neighbors see when they peek into each other's yards, so make a style statement with a minimalist metal railing.

Photo: Impression Rail Express® in Black



Impression Rail™

MODERN. STURDY. MINIMALIST.



TOP RAIL SIZE:
1.8" X 1.6"

Color Options



Impression Rail Kits, Stair Kits, and Post Kits

| PRODUCT DESCRIPTION | TimberTech Model Number | |
|---|-------------------------|------------------|
| | BLACK | BRONZE |
| IMPRESSION RAIL KITS - Kits include Top & Bottom Rail, Balusters, Level Brackets, Hardware and Footblocks | | |
| 36" 6' Level Rail Kit - 16 Aluminum Balusters included | AZTIR36KIT6B | AZTIR36KIT6BR |
| 42" 6' Level Rail Kit - 16 Aluminum Balusters included | AZTIR42KIT6B | AZTIR42KIT6BR |
| 36" 8' Level Rail Kit - 22 Aluminum Balusters included | AZTIR36KIT8B | AZTIR36KIT8BR |
| 42" 8' Level Rail Kit - 22 Aluminum Balusters included | AZTIR42KIT8B | AZTIR42KIT8BR |
| 36" 10' Level Rail Kit - 27 Aluminum Balusters included | AZTIR36KIT10B | AZTIR36KIT10BR |
| 42" 10' Level Rail Kit - 27 Aluminum Balusters included | AZTIR42KIT10B | AZTIR42KIT10BR |
| IMPRESSION RAIL STAIR KITS - Stair kits include Top & Bottom Rail, Balusters, 35° Stair Brackets, Hardware, and Footblocks | | |
| 36" 8' Stair Rail Kit - 22 Aluminum Balusters included | AZTIR36SKIT8B | AZTIR36SKIT8BR |
| 42" 8' Stair Rail Kit - 22 Aluminum Balusters included | AZTIR42SKIT8B | AZTIR42SKIT8BR |
| IMPRESSION RAIL POST KIT - Includes Post, Cap, and Skirt | | |
| 2" x 2" - 37" Post Kit for 36" Rail | AZTIR2X2PK37B | AZTIR2X2PK37BR |
| 2" x 2" - 43" Post Kit for 36" Stairs or 42" Level | AZTIR2X2PK43B | AZTIR2X2PK43BR |
| 2" x 2" - 54" Post Kit for 42" Stairs | AZTIR2X2PK54B | AZTIR2X2PK54BR |
| 3" x 3" - 38" Post Kit for 36" Rail | AZTIR3X3PK38B | AZTIR3X3PK38BR |
| 3" x 3" - 44" Post Kit for 36" Stairs or 42" Level | AZTIR3X3PK44B | AZTIR3X3PK44BR |
| 3" x 3" - 54" Post Kit for 42" Stairs | AZTIR3X3PK54B | AZTIR3X3PK54BR |
| 3" x 3" Commercial - 44" Post Kit for 42" IBC Rail | AZTIR3X3CPK44B | — |
| IMPRESSION RAIL OVER THE POST - Includes Skirt and Over-the-Post Bracket | | |
| 2" x 2" - For 36" Level Rail | AZTIR2X2OTPL36B | AZTIR2X2OTPL36BR |
| 2" x 2" - For 36" Fixed Stair Rail | AZTIR2X2OTPS36B | AZTIR2X2OTPS36BR |
| IMPRESSION RAIL BRACKET KITS - Set of 4 | | |
| Level Rail Bracket Kit - 2 Top, 2 Bottom | AZTIRBKTKITB | AZTIRBKTKITBR |
| Level Rail 45° Bracket Kit - 2 Top, 2 Bottom | AZTIRBKT45KITB | AZTIRBKT45KITBR |
| Level Rail 22½° Bracket Kit - 2 Top, 2 Bottom | AZTIRBKT22KITB | AZTIRBKT22KITBR |
| Level Rail 4" Site Cut Bracket Kit - 2 Top, 2 Bottom | AZTIRBKTSCKITB | AZTIRBKTSCKITBR |
| Fixed Stair Bracket Kit - 2 Top, 2 Bottom for 34° Stairs | AZTIRSBKTFKITB | AZTIRSBKTFKITBR |
| Adjustable Stair Rail Bracket Kit | AZTIRSBKTKITB | AZTIRSBKTKITBR |
| IMPRESSION RAIL FASTENER KIT | | |
| Fastener Kit for Composite Posts & Top Rail | AZTIRCFASTKITB | — |
| IMPRESSION RAIL TOOLS | | |
| Installation Tool (Pre-drilling template for 2" & 3" post) | AZTIRIT | — |
| Touch-Up Paint | AZTIRTUPB | AZTIRTUPBR |
| 2" Mounting Plate | AZTIR2X2MP | — |
| 3" Mounting Plate | AZTIR3X3MP | — |

Rail Kits include aluminum top and bottom rails, brackets, hardware and rectangular balusters. Posts kits are available in 2" and 3" and include a pyramid post cap and post skirt. Impression Rail can also be used with composite post sleeves and RadianceRail top rail for customization.



Impression Rail Express® Series

CONTEMPORARY. STRONG. UNOBSTRUCTIVE.



CLASSIC

TOP RAIL SIZE
2.5" X 2.3"



MODERN

TOP RAIL SIZE
2.25" X 1.8"



DRINK RAIL

TOP RAIL SIZE
2.7" X 5.5"



Color Options

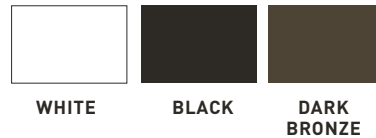

Impression Rail Express Panels

| PRODUCT DESCRIPTION | TimberTech Model Number | | |
|---|-------------------------|-----------------|------------------|
| | WHITE | BLACK | DARK BRONZE |
| IMPRESSION RAIL EXPRESS STANDARD UNIVERSAL PANEL - Baluster Panel, Bottom Rail, Bracket Hardware, Footblocks (TOP RAIL NOT INCLUDED) | | | |
| 36" 6' Level Universal Panel - 15 Baluster Panel | AZTIX36UNLP6W | AZTIX36UNLP6B | AZTIX36UNLP6BR |
| 42" 6' Level Universal Panel- 15 Baluster Panel | AZTIX42UNLP6W | AZTIX42UNLP6B | AZTIX42UNLP6BR |
| 36" 8' Level Universal Panel - 20 Baluster Panel | AZTIX36UNLP8W | AZTIX36UNLP8B | AZTIX36UNLP8BR |
| 42" 8' Level Universal Panel - 20 Baluster Panel | AZTIX42UNLP8W | AZTIX42UNLP8B | AZTIX42UNLP8BR |
| IMPRESSION RAIL EXPRESS STANDARD UNIVERSAL STAIR PANEL - Baluster Panel, Bottom Rail, Bracket Hardware, Footblocks (TOP RAIL NOT INCLUDED) | | | |
| 36" 6' Stair Universal Panel - 15 Baluster Panel | AZTIX36UNSP6W | AZTIX36UNSP6B | AZTIX36UNSP6BR |
| 42" 6' Stair Universal Panel- 15 Baluster Panel | AZTIX42UNSP6W | AZTIX42UNSP6B | AZTIX42UNSP6BR |
| 36" 8' Stair Universal Panel - 20 Baluster Panel | AZTIX36UNSP8W | AZTIX36UNSP8B | AZTIX36UNSP8BR |
| 42" 8' Stair Universal Panel - 20 Baluster Panel | AZTIX42UNSP8W | AZTIX42UNSP8B | AZTIX42UNSP8BR |
| IMPRESSION RAIL EXPRESS UNIVERSAL GLASS PANEL KIT - (1/4" Tempered Glass sold separately) | | | |
| Universal Glass Panel Kit | AZTIXUGLASSP6W | AZTIXUGLASSP6B | AZTIXUGLASSP6BR |
| Universal Glass Slats Kit | AZTIXUGLASSSL6W | AZTIXUGLASSSL6B | AZTIXUGLASSSL6BR |
| Glass Panel Extra Bracket Kit | AZTIXGBTKITW | AZTIXGBTKITB | AZTIXGBTKITBR |
| Glass Level 22½° Bracket Kit | AZTIXGBKT22KITW | AZTIXGBKT22KITB | AZTIXGBKT22KITBR |

Top Rails

| TOP RAILS (for Drink Rail please refer to "Drink Rail and Custom Top Rail Components" below) | | | |
|--|----------------|----------------|-----------------|
| 6' Classic Top Rail | AZTIXCSTR6W | AZTIXCSTR6B | AZTIXCSTR6BR |
| 8' Classic Top Rail | AZTIXCSTR8W | AZTIXCSTR8B | AZTIXCSTR8BR |
| 6' Modern Top Rail | AZTIXMDTR6W | AZTIXMDTR6B | AZTIXMDTR6BR |
| 8' Modern Top Rail | AZTIXMDTR8W | AZTIXMDTR8B | AZTIXMDTR8BR |
| DRINK RAIL AND CUSTOM TOP RAIL COMPONENTS | | | |
| 6' Universal Panel Cover (for drink rail and open mid-rail) | AZTBULKIXBR6W | AZTBULKIXBR6B | AZTBULKIXBR6BR |
| 8' Universal Panel Cover (for drink rail and open mid-rail) | AZTBULKIXBR8W | AZTBULKIXBR8B | AZTBULKIXBR8BR |
| 6' Unpunched Support Channel for open mid-rail* | AZTBULKIXCHN6W | AZTBULKIXCHN6B | AZTBULKIXCHN6BR |
| 8' Unpunched Support Channel For open mid-rail* | AZTBULKIXCHN8W | AZTBULKIXCHN8B | AZTBULKIXCHN8BR |
| Drink Rail Kit -12 Clips with Screws (3 clips/6' section & 4 clips/8' section) | AZTIXDRCKITW | AZTIXDRCKITB | AZTIXDRCKITBR |
| Drink Rail 3" Post Insert - 8 pack (works for all colors) | | AZTIX3X3PPLG | |

Rail panels include balusters, top and bottom rails, and hardware to fasten the railing to the posts. 3" Post kits include cap and skirt. 2" posts kits include bracket to run rail over the post and skirt.

Post Kits and Accessories

| PRODUCT DESCRIPTION | TimberTech Model Number | | |
|--|-------------------------|----------------|-----------------|
| | WHITE | BLACK | DARK BRONZE |
| IMPRESSION RAIL EXPRESS STANDARD 3" POST KIT - Includes Post, Cap, and Skirt | | | |
| 38" x 3" x 3" Post Kit | AZTIX3X3PK38W | AZTIX3X3PK38B | AZTIX3X3PK38BR |
| 43" x 3" x 3" Post Kit | AZTIX3X3PK43W | AZTIX3X3PK43B | AZTIX3X3PK43BR |
| 48" x 3" x 3" Post Kit | AZTIX3X3PK48W | AZTIX3X3PK48B | AZTIX3X3PK48BR |
| IMPRESSION RAIL EXPRESS ALUMINUM POST SKIRTS | | | |
| 2-Piece Aluminum Post Skirt for 3" Post | AZTIX3X3SKTALW | AZTIX3X3SKTALB | AZTIX3X3SKTALBR |
| IMPRESSION RAIL EXPRESS® 3" FASCIA MOUNT POST KITS AND BRACKET KITS - Includes Post, Cap, and Skirt | | | |
| Fascia Mount 52" Post Kit (post, cap and base insert) | AZTIX3X3FP52W | AZTIX3X3FP52B | AZTIX3X3FP52BR |
| Fascia Mount Bracket Kit Straight | AZTIX3X3FBSW | AZTIX3X3FBSB | AZTIX3X3FBSBR |
| Fascia Mount Bracket Outside Corner | AZTIX3X3FBOCW | AZTIX3X3FBOCB | AZTIX3X3FBOCBR |
| Fascia Mount Bracket Inside Corner | AZTIX3X3FBICW | AZTIX3X3FBICB | AZTIX3X3FBICBR |
| IMPRESSION RAIL EXPRESS 4" POST COMPONENTS | | | |
| 4" x 39" Post Sleeve | AZTIX4x4PS39W | AZTIX4x4PS39B | AZTIX4x4PS39BR |
| 4" x 48" Post Sleeve | AZTIX4x4PS48W | AZTIX4x4PS48B | AZTIX4x4PS48BR |
| 4" x 108" Post Sleeve | AZTIX4x4PS108W | AZTIX4x4PS108B | AZTIX4x4PS108BR |
| 4" Post Cap | AZTIX4x4PCW | AZTIX4x4PCB | AZTIX4x4PCBR |
| 4" Post skirt (2 piece polymer based skirt) | AZTIX4x4PSKW | AZTIX4x4PSKB | AZTIX4x4PSKBR |
| IMPRESSION RAIL EXPRESS OVER-THE-POST 2" POST KIT | | | |
| 36" x 2" x 2" Over-the-Post Bracket & Skirt | AZTIX2X2PK36W | AZTIX2X2PK36B | AZTIX2X2PK36BR |
| 42" x 2" x 2" Over-the-Post Bracket & Skirt | AZTIX2X2PK42W | AZTIX2X2PK42B | AZTIX2X2PK42BR |
| 18' Classic Top Rail | AZTBULKIXTR18W | AZTBULKIXTR18B | AZTBULKIXTR18BR |
| NEW! 18' Modern Top Rail | AZTIXBMDTR18W | AZTIXBMDTR18B | AZTIXBMDTR18BR |

Decorative Collars

| PRODUCT DESCRIPTION | TimberTech Model Number | | |
|--|-------------------------|----------------|-----------------|
| | WHITE | BLACK | DARK BRONZE |
| NEW! DECORATIVE COLLARS | | | |
| Decorative Collar Kit - Classic (2 top rail & 2 bottom rail collars) | AZTIXLCVRKITW | AZTIXLCVRKITB | AZTIXLCVRKITBR |
| 35° Stair Decorative Collar Kit - Classic (2 top rail & 2 bottom rail collars)* | AZTIXSCVRKITW | AZTIXSCVRKITB | AZTIXSCVRKITBR |
| Level Classic Top Rail Decorative Collar Bulk (30 Classic top rail collars)* | AZTIXLTCVR30W | AZTIXLTCVR30B | AZTIXLTCVR30BR |
| 35° Stair Classic Top Rail Decorative Collar Bulk (30 Classic Top rail collars)* | AZTIXSTCVR30W | AZTIXSTCVR30B | AZTIXSTCVR30BR |
| Level Decorative Collar Kit - Modern (2 top rail & 2 bottom rail collars)* | AZTIXLMDCKITW | AZTIXLMDCKITB | AZTIXLMDCKITBR |
| 35° Stair Decorative Collar Kit - Modern (2 top rail & 2 bottom rail collars)* | AZTIXSMDCKITW | AZTIXSMDCKITB | AZTIXSMDCKITBR |
| Level Modern Top Rail Decorative Collar Bulk (30 Modern top rail collars)* | AZTIXLTMDDC30W | AZTIXLTMDDC30B | AZTIXLTMDDC30BR |
| 35° Stair Modern Top Rail Decorative Collar Bulk (30 Modern Top Rail collars) | AZTIXSTMDDC30W | AZTIXSTMDDC30B | AZTIXSTMDDC30BR |
| Level Bottom Rail Decorative Collar Bulk (30 Bottom Rail collars)* | AZTIXLBCVR30W | AZTIXLBCVR30B | AZTIXLBCVR30BR |
| 35° Stair Bottom Rail Decorative Collar Bulk (30 bottom rail collars)* | AZTIXSBCVR30W | AZTIXSBCVR30B | AZTIXSBCVR30BR |

Installation Tools and Brackets

| IMPRESSION RAIL EXPRESS INSTALLATION TOOLS & BRACKETS | | | |
|--|---------------|----------------|----------------|
| Touch-Up Paint and Bracket Jig - Order at least 1 per job | AZTIXACCKITW | AZTIXACCKITB | AZTIXACCKITBR |
| Wall Mount Kit | AZTIXWBKTKITW | AZTIXWBKTKITB | AZTIXWBKTKITBR |
| Extra Bracket Kit Level and Stair | — | AZTIXBKTKIT | — |
| Level 22.5° Angle Bracket Kit | — | AZTIXBKT22KIT | — |
| Level 45° Angle Wall Bracket Kit | — | AZTIXWBKT45KIT | — |

How to Order:

1 Select preferred style and color

2 Select preferred infill

3 Select post sleeve and finishing touches — caps, skirts, lighting

1. STYLES AND COLORS

2. INFILLS

3. POSTS SLEEVES

3. CAPS AND SKIRTS

3. LIGHTING

Impression Rail™

1.8"W x 1.6"T

Color Options



.75" x .56" Aluminum Rectangular



2" x 2"
3" x 3"



2" x 2" Cap
2.36" x 2.36" Profile



2" x 2" Skirt
3.88" x 3.88" Profile



3" x 3" Cap
3.39" x 3.39" Profile



3" x 3" Skirt
4.91" x 4.91" Profile



Impression Rail Express® Series

Color Options

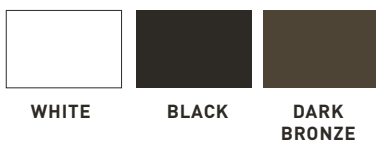

Classic

2.5" x 2.3"



Modern

2.25" x 1.8"



Drink Rail

2.7" x 5.5"



Aluminum Balusters
Rectangular only

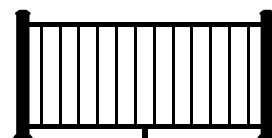

Aluminum Balusters
With open mid-rail

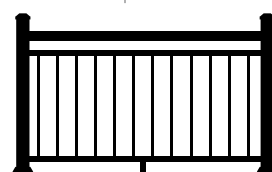

Glass Channel Kit
Glass Not Included



Glass Channel Kit
With open mid-rail



For 3" Post Applications

3" x 3" Post



3" x 3" Cap
3.39" x 3.39" Profile



3" x 3" Skirt
5.38" x 5.38" Profile



For Over the Post Applications

2" x 2" Post



2" x 2" Skirt
3.88" x 3.88" Profile



For 4" Post Applications

4" x 4" Post Sleeve



4" x 4" Cap
4.4" x 4.4" Profile



4" x 4" Skirt
5.38" x 5.38" Profile



3" x 3"
Indirect Light Post Cap



3" x 3"
Perimeter Light Post Cap





Composite ADA Handrail

- ADA-compliant Handrail system that has aluminum reinforcement that reduces bowing and provides enduring strength
- Adjustable joiners to accommodate any transition
- Installs easily with no special tools required

Color Options



WHITE



BLACK

| PRODUCT DESCRIPTION | TimberTech Model Number | |
|---|-------------------------|---------------|
| | WHITE | BLACK |
| COMPOSITE ADA HANDRAIL | | |
| ADA 104" Grab Rail | AZTADA104RSAW | AZTADA104RSAB |
| ADA 90° Corner with Joiners | AZTADA90DCWJW | AZTADA90DCWJB |
| ADA 90° Inside Corner Bracket | AZTADA90DICBW | AZTADA90DICBB |
| ADA Grab Rail End Cap - 4/Pkg | AZTADARECW | AZTADARECB |
| ADA Hand Rail Bracket Kit | AZTADAHRBKW | AZTADAHRBKB |
| ADA Handicap Loop | AZTADAHLW | AZTADAHLB |
| ADA Joint Ring - 4/Pkg | AZTADAJRW | AZTADAJRB |
| ADA Post Return | AZTADAPRW | AZTADAPRB |
| ADA Rail End Cap - 4/Pkg | AZTADARECW | AZTADARECB |
| ADA Straight Wall Return Kit | AZTADASWRKW | AZTADASWRKB |
| ADA Wall Return Cover Plate - 4/Pkg | AZTADAWRCPW | AZTADAWRCPB |
| ADA Wall Return with Joiner, Cover, and Plate | AZTADAWRCPWJW | AZTADAWRCPWJB |
| ADA External Adjustable Joiner | AZTADAEA JW | AZTADAEA JB |
| | TimberTech Model Number | |
| ADA Straight Joiner - 4/Pkg | AZTADASJ | |
| ADA Adjustable Joiner - 4/Pkg | AZTADAAJ | |

Metal ADA Handrail

- ADA-Compliant system is powder coated aluminum and passes codes for guard rail loads.
- Adjustable joiners to accommodate any transition
- Installs easily with no special tools required

| PRODUCT DESCRIPTION | TimberTech Model Number | | |
|--|-------------------------|------------------|-------------------|
| | WHITE | BLACK | DARK BRONZE |
| ADA HANDRAIL FOR IMPRESSION RAIL EXPRESS® - Kits include all the components for the most common ADA Handrail applications. Combine kits for a custom application. | | | |
| Aluminum ADA Pipe Rail and 90° Return Kit Black (2- Wall Return Brackets, 1.5" x 94" aluminum railing; 2 backer plates, hardware, Rings and Covers) | AZTIXADAPR90DRKW | AZTIXADAPR90DRKB | AZTIXADAPR90DRKBR |
| Aluminum ADA Pipe Rail Extension Kit (2- Support Brackets, 1.5" x 94" aluminum railing; 2 backer plates, hardware, connectors and covers) | AZTIXADAPREKW | AZTIXADAPREKB | AZTIXADAPREKBR |
| Aluminum ADA Handicap Loop Kit (2- "D" Loops, 1- support Brackets; 2 adjustable joiners, 2 backer plates, hardware, connectors and covers) | AZTIXADAHLKW | AZTIXADAHLKB | AZTIXADAHLKBR |
| Aluminum ADA 90° Wall Return Kit (2 Wall Return Brackets, Hardware, Rings, Covers and backer plates) | AZTIXADA90DRKW | AZTIXADA90DRKB | AZTIXADA90DRKBR |
| Aluminum ADA Support Bracket - 1 Support Bracket & Hardware | AZTIXADAMSBW | AZTIXADAMSBB | AZTIXADAMSBBR |
| Aluminum ADA Adjustable Elbow | AZTIXADAADJW | AZTIXADAADJB | AZTIXADAADJBR |
| Aluminum ADA 90 Degree Wall Return, Hardware and Ring Cover | AZTIXADA90WRW | AZTIXADA90WRB | AZTIXADA90WRBR |
| Aluminum ADA Handrail Pipes 1.5" x 94" | AZTIXADA94RW | AZTIXADA94RB | AZTIXADA94RBR |



WHITE



BLACK



DARK BRONZE



Secure Mount Post

- Allows railing installations without a wood post
- Can be installed on wood decks and concrete surfaces

| PRODUCT DESCRIPTION | TimberTech Model Number |
|------------------------------|-------------------------|
| SECURE MOUNT POST | |
| 4" Secure Mount Post | AZTSMP3642 |
| 6" Secure Mount Post Adapter | AZTSMP6ADAPT0R |
| Deck Mounting Kit | AZTSMPDMK |



Universal Gate Kit

- A composite gate kit compatible with the Classic Composite Series
- Does not include top rail, bottom rail, or balusters
- Maximum width opening is 48"

| PRODUCT DESCRIPTION | TimberTech Model Number | | |
|--|-------------------------|----------|-------------|
| | WHITE | BLACK | MATTE WHITE |
| UNIVERSAL GATE KIT - For use with Classic Composite Series Includes Hinges and Latch and side supports to convert Calssic Composite Rail Pack or Kit to a gate (Railing and balusters sold separately) | | | |
| 36" Universal Gate Kit | AZTGATEW | AZTGATEB | AZTGATEMW |

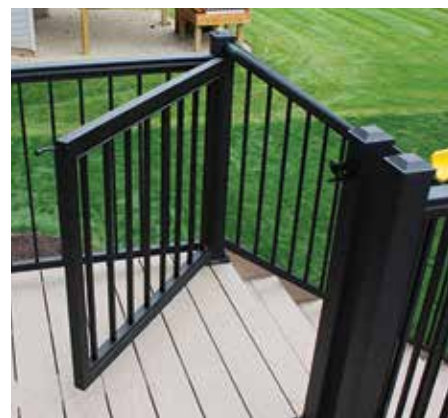

Impression Rail Express® Gate Kit

- For 36" or 42" rail heights
- Available in White, Black, or Dark Bronze

| PRODUCT DESCRIPTION | TimberTech Model Number | | |
|---|-------------------------|--------------|---------------|
| | WHITE | BLACK | DARK BRONZE |
| IMPRESSION RAIL EXPRESS GATE KIT - Kit includes Panel, Top & Bottom Channel Covers, Latch and Hinge Kit (for up to 50" openings) | | | |
| 36" IRX Gate Kit | AZTIXGATE36W | AZTIXGATE36B | AZTIXGATE36BR |
| 42" IRX Gate Kit | AZTIXGATE42W | AZTIXGATE42B | AZTIXGATE42BR |



TIMBERTECH® LIGHTING

Add the finishing touches to your deck and railing project with quality lighting options. Our lighting radiates sophistication and quality—an elegant enhancement to an already beautiful space.



Deck Lighting

| PRODUCT DESCRIPTION | TimberTech Model Number |
|--|-------------------------|
| DECK LIGHTING | |
| LED In-Deck Light - Architectural Bronze - 4/Pkg | AZTDLLEDINDECKG2 |
| LED Riser Light - Architectural Bronze | AZTDLLEDRISERB |
| LED Riser Light - White | AZTDLLEDRISERW |
| 100w Transformer for LED Lighting (12 volt) | AZTDL100TRAN |
| 16/2 100' wire for LED Lighting | AZTDLLEDWIRE |
| 150W PowerPack/Dimmer | AZTDL150PP |



IN-DECK LIGHT



RISER LIGHT



POST CAP LIGHT



LIGHTED ISLAND CAP



ACCENT LIGHT



UNDER RAIL LIGHT



INDIRECT LIGHT POST CAP



PERIMETER LIGHT POST CAP

Composite Rail Lighting

| PRODUCT DESCRIPTION | TimberTech Model Number |
|---|-------------------------|
| COMPOSITE RAIL LIGHTING | |
| 4" x 4" LED Post Cap Light | TDL4X4CAPMOD |
| 5" x 5" LED Post Cap Light | TDL5X5CAPMOD |
| 5 1/2" x 5 1/2" LED Post Cap Light | ADL55X55CAPMOD |
| 5 1/2" x 5 1/2" LED Lighted Island Cap - Black | ADL55X55ICAPMODB |
| 5 1/2" x 5 1/2" LED Lighted Island Cap - White | ADL55X55ICAPMODW |
| 5 1/2" x 5 1/2" LED Lighted Island Cap - Matte White | ADL55X55ICAPMODMW |
| 5 1/2" x 5 1/2" LED Lighted Island Cap - Matte Black | ADL55X55ICAPMODMB |
| 5 1/2" x 5 1/2" LED Lighted Island Cap - Matte Espresso | ADL55X55ICAPMODME |
| LED Accent Light - Architectural Bronze | AZTDLLEDACCB |
| LED Accent Light - White | AZTDLLEDACCW |
| LED Accent Light - Matte White | AZTDLLEDACCMW |
| LED Under Rail Light - 4/Pkg | AZTDLLEDURAIL |

Impression Rail Express® Lighting

| PRODUCT DESCRIPTION | TimberTech Model Number |
|--|-------------------------|
| IMPRESSION RAIL EXPRESS® LIGHTING | |
| 3" x 3" Perimeter Light Post Cap - Black | AZTIXLIGPCB |
| 3" x 3" Perimeter Light Post Cap - White | AZTIXLIGPCW |
| 3" x 3" Perimeter Light Post Cap - Dark Bronze | AZTIXLIGPCBR |
| 3" x 3" Indirect/Concealed Down Light Post Cap - Black | AZTIXLIGDCB |
| 3" x 3" Indirect/Concealed Down Light Post Cap - White | AZTIXLIGDCW |
| 3" x 3" Indirect/Concealed Down Light Post Cap - Dark Bronze | AZTIXLIGDCBR |

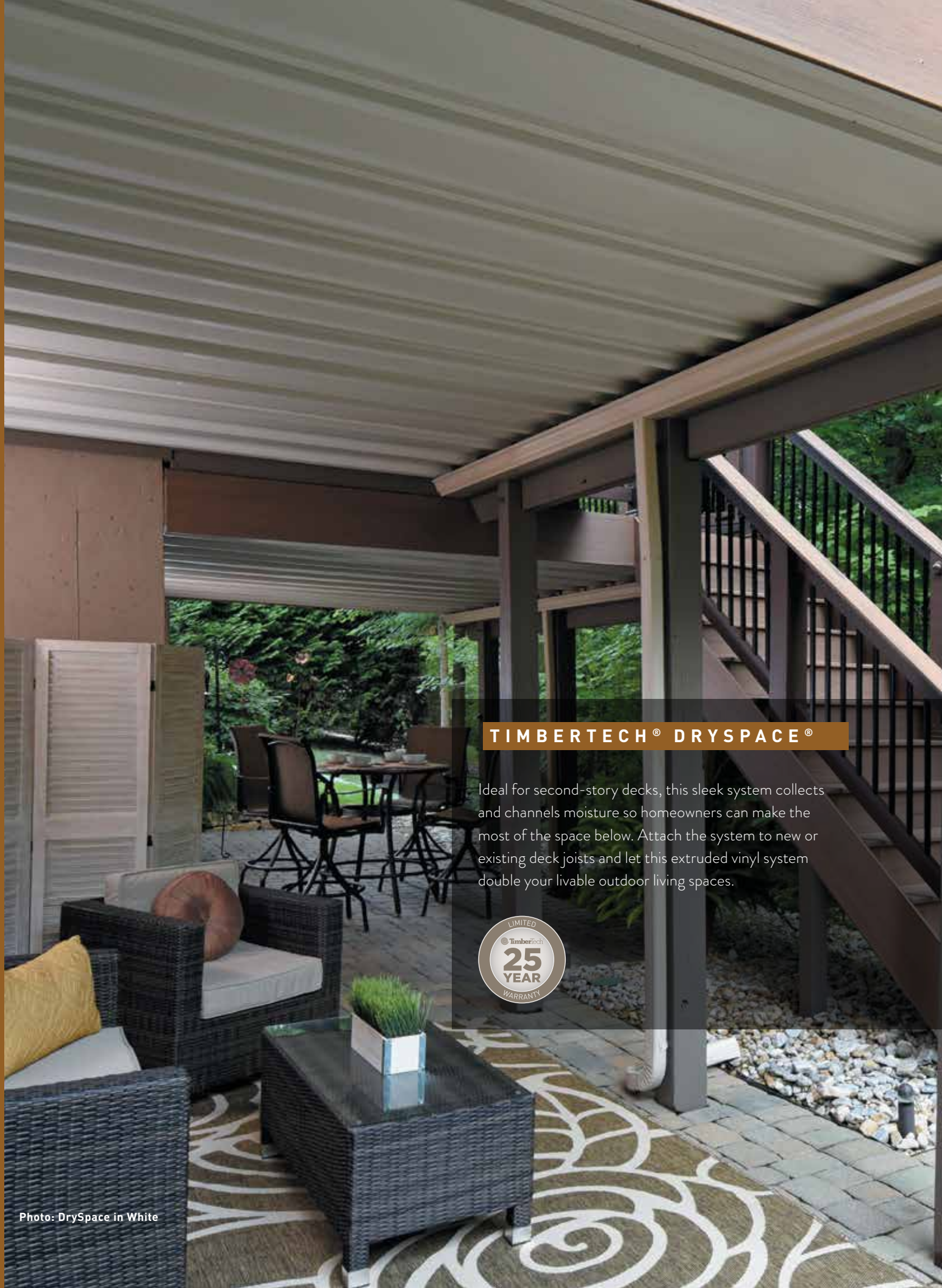

TIMBERTECH® DRYSpace®

Ideal for second-story decks, this sleek system collects and channels moisture so homeowners can make the most of the space below. Attach the system to new or existing deck joists and let this extruded vinyl system double your livable outdoor living spaces.



Photo: DrySpace in White

DrySpace®

Available In:

- 12" on-center spans in 12' lengths
- 16" on-center spans in 12' and 16' length

| PRODUCT DESCRIPTION | TimberTech Model Number | | | |
|-----------------------|-------------------------|---------------|---------------|---------------|
| | 12' BONE | 16' BONE | 12' WHITE | 16' WHITE |
| DRYSpace | | | | |
| Combo Brackets | DSCOMBO12B | DSCOMBO16B | DSCOMBO12W | DSCOMBO16W |
| Double Combo Brackets | — | DSDBLCOMBO16B | — | DSDBLCOMBO16W |
| 12" Panel Only | DS12PANEL12B | DS12PANEL16B | DS12PANEL12W | DS12PANEL16W |
| 16" Panel Only | DS16PANEL12B | DS16PANEL16B | DS16PANEL12W | DS16PANEL16W |
| Ledger Bracket | DSFBRACKET12B | — | DSFBRACKET12W | — |
| 12" O.C. DrySpace Kit | DS12KIT12B | — | DS12KIT12W | — |
| 16" O.C. DrySpace Kit | DS16KIT12B | DS16KIT16B | DS16KIT12W | DS16KIT16W |

Color Options



SINGLE COMBO BRACKET



LEDGER F BRACKET



DOUBLE COMBO BRACKET



#1 in Performance Trim





#1 in Performance Trim

AZEK Trim is the perfect replacement for wood trim and also performs beautifully as fascia, soffit, beadboard, cornerboards, window and door surrounds, column wraps, decorative mouldings, millwork, and much more.



AZEK® Trim with Protective Film

AZEK Trim is cellular PVC with a crisp white semi-matte finish providing years of low maintenance for homeowners. To ensure that it looks as beautiful on your homes as it does when it leaves our facilities, our Classic AZEK Trim in Smooth and Woodgrain finish is now produced with a protective film.

AZEK Trim with protective film should be kept dry prior to installation. Do not expose film to direct sunlight for extended periods. Protective film can be removed prior to, during or immediately after installation.

AZEK TRIM FILM WILL BE ON THE FOLLOWING SMOOTH AND WOODGRAIN TRIM PRODUCTS

| Nominal Thickness | Nominal Width | | | | | | |
|-------------------|---------------|---|---|---|----|----|----|
| | 4 | 5 | 6 | 8 | 10 | 12 | 16 |
| 5/8 | • | • | • | • | • | • | • |
| 4/4 | • | • | • | • | • | • | • |
| 5/4 | • | • | • | • | • | • | • |



| | 12' | 18' | 20' |
|---------------------------------------|------------|------------|-----|
| 5/8" TRIMBOARD, 5/8" THICKNESS | | | |
| 5/8" x 3-1/2" Trimboard Smooth | AT06204144 | AT06204216 | — |
| 5/8" x 3-1/2" Trimboard Woodgrain | AF06204144 | AF06204216 | — |
| 5/8" x 5-1/2" Trimboard Smooth | AT06206144 | AT06206216 | — |
| 5/8" x 5-1/2" Trimboard Woodgrain | AF06206144 | AF06206216 | — |
| 5/8" x 7-1/4" Trimboard Smooth | AT06208144 | AT06208216 | — |
| 5/8" x 7-1/4" Trimboard Woodgrain | AF06208144 | AF06208216 | — |
| 5/8" x 9-1/4" Trimboard Smooth | AT06210144 | AT06210216 | — |
| 5/8" x 9-1/4" Trimboard Woodgrain | AF06210144 | AF06210216 | — |
| 5/8" x 11-1/4" Trimboard Smooth | AT06212144 | AT06212216 | — |
| 5/8" x 11-1/4" Trimboard Woodgrain | AF06212144 | AF06212216 | — |
| 5/8" x 15-1/4" Trimboard Smooth | AT06216144 | AT06216216 | — |
| 5/8" x 15-1/4" Trimboard Woodgrain | AF06216144 | AF06216216 | — |

| | 12' | 18' | 20' |
|---------------------------------------|------------------------------------|------------|------------|
| 4/4" TRIMBOARD, 3/4" THICKNESS | | | |
| Nominal | Actual | | |
| 4/4 x 2 | 3/4" x 1-1/2" Trimboard Smooth | — | AT10002216 |
| 4/4 x 2 | 3/4" x 1-1/2" Trimboard Woodgrain | — | AF10002216 |
| 4/4 x 4 | 3/4" x 3-1/2" Trimboard Smooth | AT10004144 | AT10004216 |
| 4/4 x 4 | 3/4" x 3-1/2" Trimboard Woodgrain | AF10004144 | AF10004216 |
| 4/4 x 5 | 3/4" x 4-1/2" Trimboard Smooth | AT10005144 | AT10005216 |
| 4/4 x 5 | 3/4" x 4-1/2" Trimboard Woodgrain | AF10005144 | AF10005216 |
| 4/4 x 6 | 3/4" x 5-1/2" Trimboard Smooth | AT10006144 | AT10006216 |
| 4/4 x 6 | 3/4" x 5-1/2" Trimboard Woodgrain | AF10006144 | AF10006216 |
| 4/4 x 8 | 3/4" x 7-1/4" Trimboard Smooth | AT10008144 | AT10008216 |
| 4/4 x 8 | 3/4" x 7-1/4" Trimboard Woodgrain | AF10008144 | AF10008216 |
| 4/4 x 10 | 3/4" x 9-1/4" Trimboard Smooth | AT10010144 | AT10010216 |
| 4/4 x 10 | 3/4" x 9-1/4" Trimboard Woodgrain | AF10010144 | AF10010216 |
| 4/4 x 12 | 3/4" x 11-1/4" Trimboard Smooth | AT10012144 | AT10012216 |
| 4/4 x 12 | 3/4" x 11-1/4" Trimboard Woodgrain | AF10012144 | AF10012216 |
| 4/4 x 16 | 3/4" x 15-1/4" Trimboard Smooth | AT10016144 | AT10016216 |
| 4/4 x 16 | 3/4" x 15-1/4" Trimboard Woodgrain | AF10016144 | AF10016216 |

Classic AZEK Trim, Smooth and Woodgrain

AZEK Trim is a finishing touch that is far superior to wood. AZEK Trim is more durable and keeps its appearance longer with little maintenance. It is easily milled, routed and heat formed for exquisite custom looks or curved applications. No staining or sealing needed. AZEK Trim is easily painted for personal styling.



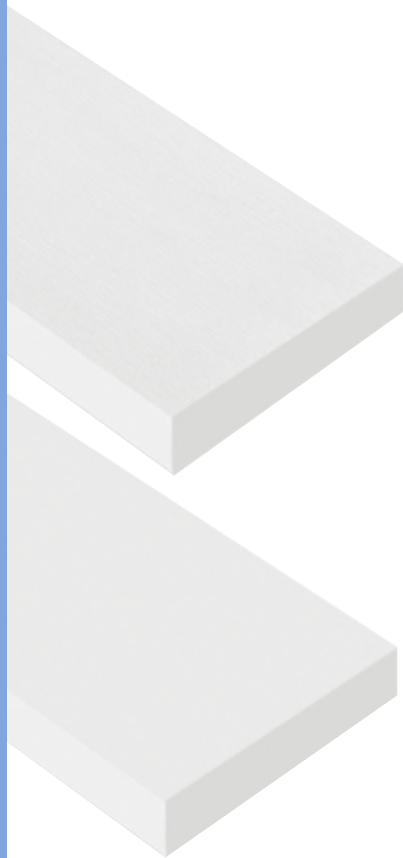

AZEK® Trim with PaintPro® Technology

No primer needed. Get work finished faster thanks to quicker drying time. PaintPro can be handled 30 minutes after painting. AZEK Trim with PaintPro technology has all the benefits of AZEK Classic Trim including being virtually impervious to moisture, but also adds the benefit of a superior paint bond that enhances long-term performance.

Classic AZEK Sheet

Applications over 16" wide are easy with Classic AZEK Sheet. Ideal for use in bay windows, dormers and raised panels.

PaintPro Sheet

Applications over 16" wide are easy with AZEK PaintPro Sheet. Ideal for use in bay windows, dormers, and raised panels.

| | | 12' | 18' | 20' |
|------------------------------------|----------------------------------|------------|------------|-------------|
| 5/4 TRIMBOARD, 1" THICKNESS | | | | |
| Nominal | Actual | | | |
| 5/4 x 4 | 1" x 3-1/2" Trimboard Smooth | AT12504144 | AT12504216 | AT12504240 |
| 5/4 x 4 | 1" x 3-1/2" Trimboard Woodgrain | AF12504144 | AF12504216 | AFT12504240 |
| 5/4 x 5 | 1" x 4-1/2" Trimboard Smooth | AT12505144 | AT12505216 | AT12505240 |
| 5/4 x 5 | 1" x 4-1/2" Trimboard Woodgrain | AF12505144 | AF12505216 | AF12505240 |
| 5/4 x 6 | 1" x 5-1/2" Trimboard Smooth | AT12506144 | AT12506216 | AT12506240 |
| 5/4 x 6 | 1" x 5-1/2" Trimboard Woodgrain | AF12506144 | AF12506216 | AF12506240 |
| 5/4 x 8 | 1" x 7-1/4" Trimboard Smooth | AT12508144 | AT12508216 | AT12508240 |
| 5/4 x 8 | 1" x 7-1/4" Trimboard Woodgrain | AF12508144 | AF12508216 | AF12508240 |
| 5/4 x 10 | 1" x 9-1/4" Trimboard Smooth | AT12510144 | AT12510216 | AT12510240 |
| 5/4 x 10 | 1" x 9-1/4" Trimboard Woodgrain | AF12510144 | AF12510216 | AF12510240 |
| 5/4 x 12 | 1" x 11-1/4" Trimboard Smooth | AT12512144 | AT12512216 | AT12512240 |
| 5/4 x 12 | 1" x 11-1/4" Trimboard Woodgrain | AF12512144 | AF12512216 | AF12512240 |
| 5/4 x 16 | 1" x 15-1/4" Trimboard Smooth | AT12516144 | AT12516216 | AT12516240 |
| 5/4 x 16 | 1" x 15-1/4" Trimboard Woodgrain | AF12516144 | AF12516216 | AF12516240 |

| | | 12' | 18' | 20' |
|--|--------------------------------------|-----|-----|------------|
| 6/4 TRIMBOARD, 1-1/4" THICKNESS | | | | |
| Nominal | Actual | | | |
| 6/4 x 4 | 1-1/4" x 3-1/2" Trimboard Woodgrain | — | — | AF15004240 |
| 6/4 x 6 | 1-1/4" x 5-1/2" Trimboard Woodgrain | — | — | AF15006240 |
| 6/4 x 8 | 1-1/4" x 7-1/4" Trimboard Woodgrain | — | — | AF15008240 |
| 6/4 x 10 | 1-1/4" x 9-1/4" Trimboard Woodgrain | — | — | AF15010240 |
| 6/4 x 12 | 1-1/4" x 11-1/4" Trimboard Woodgrain | — | — | AF15012240 |

| | | 12' | 16' | 20' |
|--|----------------|-----|--------------|-----|
| PAINTPRO® TRIM Two-Sided, Reversible Finish: Smooth and Woodgrain | | | | |
| Nominal | Actual | | | |
| 4/4 x 2 | 3/4" x 1-1/2" | — | AF10002192PP | — |
| 4/4 x 3 | 3/4" x 2-1/2" | — | AF10003192PP | — |
| 4/4 x 4 | 3/4" x 3-1/2" | — | AF10004192PP | — |
| 4/4 x 6 | 3/4" x 5-1/2" | — | AF10006192PP | — |
| 4/4 x 8 | 3/4" x 7-1/4" | — | AF10008192PP | — |
| 4/4 x 10 | 3/4" x 9-1/4" | — | AF10010192PP | — |
| 4/4 x 12 | 3/4" x 11-1/4" | — | AF10012192PP | — |
| 4/4 x 16 | 3/4" x 15-1/4" | — | AF10016192PP | — |
| 5/4 x 4 | 1" x 3-1/2" | — | AF12504192PP | — |
| 5/4 x 6 | 1" x 5-1/2" | — | AF12506192PP | — |
| 5/4 x 8 | 1" x 7-1/4" | — | AF12508192PP | — |
| 5/4 x 10 | 1" x 9-1/4" | — | AF12510192PP | — |
| 5/4 x 12 | 1" x 11-1/4" | — | AF12512192PP | — |
| 5/4 x 16 | 1" x 15-1/4" | — | AF12516192PP | — |

| | | 8' | 10' | 12' | 18' | 20' |
|----------------------------|-------------|-------------|------------|------------|------------|-----|
| CLASSIC AZEK SHEET | | | | | | |
| Actual | | | | | | |
| 3/8" x 48" Sheet Smooth | AS03848096 | AS03848120 | AS03848144 | AS03848216 | — | — |
| 3/8" x 48" Sheet Woodgrain | ASF03848096 | ASF03848120 | — | — | — | — |
| 1/2" x 48" Sheet Smooth | AS01248096 | AS01248120 | AS01248144 | AS01248216 | — | — |
| 1/2" x 48" Sheet Woodgrain | ASF01248096 | ASF01248120 | — | — | — | — |
| 5/8" x 48" Sheet Smooth | AS05848096 | AS05848120 | AS05848144 | AS05848216 | — | — |
| 3/4" x 48" Sheet Smooth | AS03448096 | AS03448120 | AS03448144 | AS03448216 | — | — |
| 3/4" x 48" Sheet Woodgrain | ASF03448096 | ASF03448120 | — | — | — | — |
| 1" x 48" Sheet Smooth | AS10048096 | AS10048120 | AS10048144 | AS10048216 | AS10048240 | — |

| | | 8' | 10' | 12' | 20' |
|---|---------------|---------------|--------------|-----|-----|
| PAINTPRO® SHEET Two-Sided, Reversible Finish: Smooth and Woodgrain | | | | | |
| Actual | | | | | |
| 3/4 x 4 | ASF03448096PP | ASF03448096PP | — | — | — |
| 1/2 x 4 | ASF01248096PP | ASF01248120PP | ASF0128144PP | — | — |

| | | 8' | 10' | 12' | 18' | 20' |
|-----------------------------------|---|----|-----|------------|-----|-----|
| AZEK TO MILL | | | | | | |
| Actual | | | | | | |
| 1 1/4" x 9 1/4" ATM Board Smooth | — | — | — | AT15010216 | — | — |
| 1-1/2" x 3-1/2" ATM Board Smooth | — | — | — | AT20004216 | — | — |
| 1-1/2" x 5-1/2" ATM Board Smooth | — | — | — | AT20006216 | — | — |
| 1-1/2" x 7-1/4" ATM Board Smooth | — | — | — | AT20008216 | — | — |
| 1-1/2" x 9-1/4" ATM Board Smooth | — | — | — | AT20010216 | — | — |
| 1-1/2" x 11-1/4" ATM Board Smooth | — | — | — | AT20012216 | — | — |

| | | 8' | 10' | 12' | 18' | 20' |
|-------------------------------|------------|------------|------------|-----|------------|-----|
| AZEK TO MILL (ATM) | | | | | | |
| Actual | | | | | | |
| 1-1/4" x 48" ATM Sheet Smooth | — | AS11448096 | — | — | — | — |
| 1-1/2" x 48" ATM Sheet Smooth | AS11248096 | AS11248120 | AS11248144 | — | AS11248240 | — |

| | | 12' | 18' | 20' |
|----------------------|-----------------------|-----|-------------|-----|
| RABBETED TRIM | | | | |
| Nominal | Actual | | | |
| 5/4 x 4 | 1" x 3-1/2" Smooth | — | ATR12504216 | — |
| 5/4 x 4 | 1" x 3-1/2" Woodgrain | — | AFR12504216 | — |
| 5/4 x 6 | 1" x 5-1/2" Smooth | — | ATR12506216 | — |
| 5/4 x 6 | 1" x 5-1/2" Woodgrain | — | AFR12506216 | — |
| 5/4 x 8 | 1" x 7-1/4" Smooth | — | ATR12508216 | — |
| 5/4 x 8 | 1" x 7-1/4" Woodgrain | — | AFR12508216 | — |

| | | 12' | 18' | 20' |
|-----------------------------------|--------------------------------|-----|--------------|-----|
| FLANGE SLOTTED WINDOW TRIM | | | | |
| Nominal | Actual | | | |
| 5/4 x 4 | Slotted - Smooth | — | ATS12504216 | — |
| 5/4 x 4 | Slotted - Woodgrain | — | AFS12504216 | — |
| 5/4 x 4 | Slotted & Rabbeted - Smooth | — | ATSR12504216 | — |
| 5/4 x 4 | Slotted & Rabbeted - Woodgrain | — | AFSR12504216 | — |
| 5/4 x 6 | Slotted - Smooth | — | ATS12506216 | — |
| 5/4 x 6 | Slotted - Woodgrain | — | AFS12506216 | — |
| 5/4 x 6 | Slotted & Rabbeted - Smooth | — | ATSR12506216 | — |
| 5/4 x 6 | Slotted & Rabbeted - Woodgrain | — | AFSR12506216 | — |

| | | 8' | 10' | 12' | 18' | 20' |
|---------------------|-----------------------------------|----|-----------|-----|-----|-----------|
| CORNERBOARDS | | | | | | |
| Nominal | Actual | | | | | |
| 5/4 x 4" x 4" | 1" x 3-1/2" Cornerboard Smooth | — | AMT04120C | — | — | AMT04240C |
| 5/4 x 4" x 4" | 1" x 3-1/2" Cornerboard Woodgrain | — | AMF04120C | — | — | AMF04240C |
| 5/4 x 6" x 6" | 1" x 5-1/2" Cornerboard Smooth | — | AMT06120C | — | — | AMT06240C |
| 5/4 x 6" x 6" | 1" x 5-1/2" Cornerboard Woodgrain | — | AMF06120C | — | — | AMF06240C |
| 5/4 x 8" x 8" | 1" x 7 1/4" Cornerboard Smooth | — | — | — | — | AMT08240C |

| | | 8' | 10' | 12' | 18' | 20' |
|-------------------------------|-----------------------------------|----|-----|-----|-----|-------------|
| PAINTPRO® CORNERBOARDS | | | | | | |
| Nominal | Actual | | | | | |
| 5/4 x 4" x 4" | 1" x 3-1/2" Cornerboard Smooth | — | — | — | — | AMT04240CPP |
| 5/4 x 4" x 4" | 1" x 3-1/2" Cornerboard Woodgrain | — | — | — | — | AMF04240CPP |
| 5/4 x 6" x 6" | 1" x 5-1/2" Cornerboard Smooth | — | — | — | — | AMT06240CPP |
| 5/4 x 6" x 6" | 1" x 5-1/2" Cornerboard Woodgrain | — | — | — | — | AMF06240CPP |

| | | 8' | 10' | 12' | 18' | 20' |
|------------------------------|----------------------------------|----|------------|-----|-----|------------|
| RABBETED CORNERBOARDS | | | | | | |
| Nominal | Actual | | | | | |
| 5/4 x 4" x 4" | 1" x 3-1/2" Rabbeted - Smooth | — | AMTR04120C | — | — | AMTR04240C |
| 5/4 x 4" x 4" | 1" x 3-1/2" Rabbeted - Woodgrain | — | AMFR04120C | — | — | AMFR04240C |
| 5/4 x 6" x 6" | 1" x 5-1/2" Rabbeted - Smooth | — | AMTR06120C | — | — | AMTR06240C |
| 5/4 x 6" x 6" | 1" x 5-1/2" Rabbeted - Woodgrain | — | AMFR06120C | — | — | AMFR06240C |
| 5/4 x 8" x 8" | 1" x 7-1/4" Rabbeted - Smooth | — | — | — | — | AMTR08240C |

AZEK® to Mill (ATM)

ATM's thick profile makes it an ideal material for fabrication. Its consistent density offers a superior product for milling operations.



Rabbeted Trim

With rabbeted edges, this one-piece trimboard is designed to ease siding installation and deliver a crisp facade.

Flange Slotted Trim

Typical window trims installed over a window nailing fin need to be shimmed or pulled back for the trim to lay flat. Flange Slotted Window Trim does not and is engineered to create consistent long-lasting window surrounds by removing the installation challenges created by windows installed with a nailing fin.

Cornerboards

With dirt-free seams that will not open, AZEK® Cornerboards offer faster and more aesthetically pleasing installations to complement any home exterior.

Rabbeted Cornerboards

With rabbeted edges, this one-piece cornerboard is designed to make siding installations a breeze and help deliver a crisp facade with smooth outside edges and tight joints.



Quick Corner®

The inner and outer quick corners are installed with hidden fasteners, completely eliminating the need for excessive face nailing and touch-up. It is also versatile enough to be used with multiple types of sidings.

| | | 8' | 10' | 12' | 18' | 20' |
|-------------------------------------|---------------------------------------|----|-----|-----|-----|-------------|
| QUICK CORNER® OUTSIDE CORNER | | | | | | |
| Nominal | Actual | | | | | |
| 5/4 x 4" x 4" | 1" x 3-1/2" x 3-1/2" with J-Channel | — | — | — | — | AMT04240JC |
| 5/4 x 6" x 6" | 1" x 5-1/2" x 5-1/2" with J-Channel | — | — | — | — | AMT06240JC |
| | | 8' | 10' | 12' | 18' | 20' |
| QUICK CORNER® INSIDE CORNER | | | | | | |
| Nominal | Actual | | | | | |
| 3/8 x 3 x 3 | 3/8" x 2-1/2" x 2-1/2" with J-Channel | — | — | — | — | AMJCIC03240 |

J-Casing

J-Casing offers the most beautiful and seamless transition between your siding and trim. Engineered to reduce labor and save costs by eliminating paint and extra j-channel installs.

| | | 8' | 10' | 12' | 16' | 18' | 20' |
|-----------------|-------------------------|----|-----|-----|--------------|--------------|--------------|
| J-CASING | | | | | | | |
| Nominal | Actual | | | | | | |
| 1 x 4 | 1-1/8 x 3-1/2" J-Casing | — | — | — | AMFC04192JCB | AMFC04216JCB | — |
| 1 x 6 | 1-1/8 x 5-1/2" J-Casing | — | — | — | AMFC06144JCB | — | — |
| - | 1-1/4 x 2" Brick Mould | — | — | — | — | — | AMBM02216JCB |

Universal Skirt Board

A two-piece skirt board with a two-sided trimboard (one side in Smooth, the other in Woodgrain) designed to assist with water management. Routed with a universal siding interface. Installation is quick and easy.

| | | 8' | 10' | 12' | 18' | 20' |
|------------------------------|--|----|-----|-----|-----------|-----|
| UNIVERSAL SKIRT BOARD | | | | | | |
| Nominal | Actual | | | | | |
| 5/4 x 6" | 1" x 5-1/2" Universal Skirt Board - Woodgrain | — | — | — | AFUS07216 | — |
| 5/4 x 8" | 1" x 7-1/4" Universal Skirt Board - Woodgrain | — | — | — | AFUS09216 | — |
| 5/4 x 10" | 1" x 9-1/4" Universal Skirt Board - Woodgrain | — | — | — | AFUS11216 | — |
| 5/4 x 12" | 1" x 11 1/4" Universal Skirt Board - Woodgrain | — | — | — | AFUS12216 | — |

One-Piece Skirt Board

One-Piece Skirt Board is designed to eliminate purchasing and installing a separate starter strip, skirt board and flashing while helping drain water away from the main structure. Save time and cost without compromising aesthetics.

| | | 8' | 10' | 12' | 18' | 20' |
|------------------------------|---|----|-----|-----|--------------|-----|
| ONE-PIECE SKIRT BOARD | | | | | | |
| Nominal | Actual | | | | | |
| 4/4 x 8" | 3/4" x 7-1/4" One-Piece Skirt Board - Smooth | — | — | — | ATSB10008216 | — |
| 4/4 x 8" | 3/4" x 7-1/4" One-Piece Skirt Board - Woodgrain | — | — | — | AFSB10008216 | — |
| 4/4 x 10" | 3/4" x 9-1/4" One-Piece Skirt Board - Smooth | — | — | — | ATSB10010216 | — |
| 4/4 x 10" | 3/4" x 9-1/4" One-Piece Skirt Board - Woodgrain | — | — | — | AFSB10010216 | — |
| 5/4 x 6" | 1" x 5-1/2" One-Piece Skirt Board - Smooth | — | — | — | ATSB12506216 | — |
| 5/4 x 6" | 1" x 5-1/2" One-Piece Skirt Board - Woodgrain | — | — | — | AFSB12506216 | — |
| 5/4 x 8" | 1" x 7-1/4" One-Piece Skirt Board - Smooth | — | — | — | ATSB12508216 | — |
| 5/4 x 8" | 1" x 7-1/4" One-Piece Skirt Board - Woodgrain | — | — | — | AFSB12508216 | — |
| 5/4 x 10" | 1" x 9-1/4" One-Piece Skirt Board - Smooth | — | — | — | ATSB12510216 | — |
| 5/4 x 10" | 1" x 9-1/4" One-Piece Skirt Board - Woodgrain | — | — | — | AFSB12510216 | — |

| | | 8' | 10' | 12' | 16' | 18' | 20' |
|---------------------------------------|-------------------|----|-----|-----|----------------|-----|-----|
| ONE-PIECE SKIRT BOARD PAINTPRO | | | | | | | |
| Nominal | Actual | | | | | | |
| 5/4 x 10 x 16' | 1" x 9 1/4" x 16' | — | — | — | AFSB12510192PP | — | — |

Integrated Drip Edge

Designed to assist with water management efforts around doors and windows. Comes in two pieces with a two-sided trimboard; one side in Smooth and the other in Woodgrain. Easy to install, the drip edge has an integrated nailing flange to reduce installation time and costs.

| | | 8' | 10' | 12' | 18' | 20' |
|-----------------------------|----------------------------------|----|-----|-----|-----------|-----|
| INTEGRATED DRIP EDGE | | | | | | |
| Nominal | Actual | | | | | |
| 5/4 x 4" | 1" x 3-1/2" Integrated Drip Edge | — | — | — | AFWB05216 | — |
| 5/4 x 6" | 1" x 5-1/2" Integrated Drip Edge | — | — | — | AFWB07216 | — |
| 5/4 x 8" | 1" x 7-1/4" Integrated Drip Edge | — | — | — | AFWB09216 | — |

| | | 8' | 10' | 12' | 18' | 20' |
|----------------------------------|---------------|----|-----|-----|---------------|-----|
| BEADBOARD, SMOOTH FINISH | | | | | | |
| Actual | | | | | | |
| 3/4" x 5-1/2" Beadboard E & CB | | — | — | — | AM1006216ECB | — |
| 1/2" x 3 1/2" Beadboard E & CB | | — | — | — | AM01204216ECB | — |
| 3/4" x 3 1/2" Beadboard E & CB | | — | — | — | AM1004216ECB | — |
| 5/8" x 3-1/2" Beadboard | | — | — | — | AM0620418 | — |
| 1/2" x 5-1/2" Beadboard | | — | — | — | AM0120618F | — |
| 1/2" x 4" Beadboard Sheet E & CB | AS01248096ECB | | | | | |

| | | 8' | 10' | 12' | 18' | 20' |
|---------------------------------------|--|----|-----|-----|---------------|-----|
| TONGUE AND GROOVE | | | | | | |
| Actual | | | | | | |
| 3/4" x 5-1/2" WP4/Nickel Gap | | — | — | — | AM1006216WPN | — |
| 3/4" x 5-1/2" Tongue & Groove Shiplap | | — | — | — | AM10006216TGS | — |
| 3/4" x 7-1/4" Tongue & Groove Shiplap | | — | — | — | AM10008216TGS | — |

| | | 8'6" | 10' |
|----------------------------------|------------------|-------------------|---------------------------|
| AZEK 3-PLUS-1 COLUMN WRAP | | | |
| Nominal | Inside Dimension | Outside Dimension | |
| 4 x 4 | 3-3/4" x 3-3/4" | 4-3/4" x 4-3/4" | ATCW0404096.6 ATCW0404120 |
| 6 x 6 | 5-3/4" x 5-3/4" | 6-3/4" x 6-3/4" | ATCW0606096.6 ATCW0606120 |
| 8 x 8 | 7-3/4" x 7-3/4" | 8-3/4" x 8-3/4" | ATCW0808096.6 ATCW0808120 |

| | | 4" | 6" |
|---|---------------------|---------------------|------------------------------|
| COLUMN KITS AND ACCESSORIES (for 3-Plus-1 Column Wraps only) | | | |
| Description | | | |
| TRIM KIT - BASE MLDG | ACW4"TRIMKITBASE | ACW6"TRIMKITBASE | |
| TRIM KIT - BED MLDG | ACW4"TRIMKITBED | ACW6"TRIMKITBED | |
| TRIM KIT - BED MLDG XL* | ACW4"TRIMKITBEDXL | ACW6"TRIMKITBEDXL | |
| TRIM KIT - CROWN MLDG | ACW4"TRIMKITCROWN | ACW6"TRIMKITCROWN | |
| TRIM KIT - CROWN MLDG XL* | ACW4"TRIMKITCROWNXL | ACW6"TRIMKITCROWNXL | |
| ACCENT WRAP 10" | ACWAW040410 | ACWAW060610 | * for use with Accent Wraps. |

| | | 5' | 6' |
|---|--|--------------|--------------|
| TAPERED COLUMN WRAP | | | |
| * for use with Accent Wraps. | | | |
| Actual | | | |
| 12" base / 8" cap x 5' Tapered Column Wrap | | ATCWT1208060 | ATCWT1208072 |
| 16" base / 12" cap x 6' Tapered Column Wrap | | ATCWT1612060 | ATCWT1612072 |

| | | 12' | 18' | 20' |
|----------------------|------------------------------|-----|--------------|-----|
| SOFFIT SYSTEM | | | | |
| Nominal | Actual | | | |
| 1/2 x 12 | 1/2" x 12" Vented Soffit | — | ATVS01212216 | — |
| 1/2 x 16 | 1/2" x 16" Vented Soffit | — | ATVS01216216 | — |
| 1/2 x 12 | 1/2" x 12" Solid Soffit | — | ATSS01212216 | — |
| 1/2 x 16 | 1/2" x 16" Solid Soffit | — | ATSS01216216 | — |
| 1 x 8 | 3/4" x 7-1/4" Notched Fascia | — | AT10008216NF | — |
| 5/4 x 6 | 5/4 x 6 Frieze Board | — | AT12508216FB | — |

Beadboard

AZEK Beadboard is reversible with an edge and center bead on one side and a v-groove on the other. AZEK Beadboard (E & CB) is certified UL580 class 90 wind gust uplift-resistant, making it ideal for use in coastal areas.

Nickel Gap and Shiplap

AZEK Tongue and Groove profiles, available in shiplap and reversible WP4/nickel gap form factors, offer enhanced design and installation flexibility.

Columns

AZEK's Column Wrap profile allows for easy one-person installation, saving time and costs. Three connected panels and a fourth "locking" panel fit easily around a structural support with press fit seams and smooth, finished corners. AZEK Column Wrap is available in semi-matte white Smooth finish.

New Soffit System

Available in two profiles, Solid and Vented. Both provide climate-resistant material for smooth, beautiful finishing to match any home exterior. Add the notched fascia and frieze board and you have an efficient, easy-to-install system.



MOULDING

CREATE STUNNING DETAILS THAT LAST. Backed by AZEK's promise of high-quality and lasting performance, AZEK Moulding will retain a like-new appearance despite the tests of time and weather. With over 30 different profiles to mix and match, you can customize any build with a distinctive look.



Crown Profiles

Use AZEK Crown Moulding as decorative accents along the intersection of a wall and ceiling or choose a combination of profiles to create an elegantly custom look.

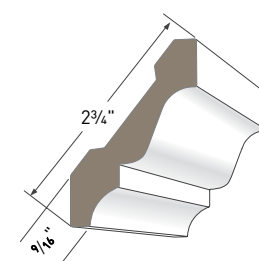

3" CROWN
AZM-52
Length: 16'

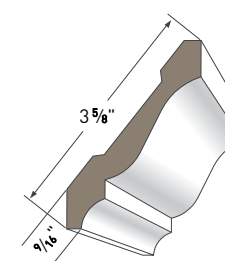

4" CROWN
AZM-49
Length: 16'

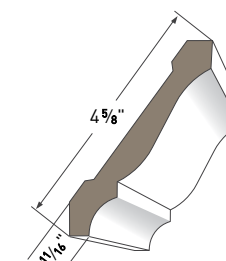

5" CROWN
AZM-47
Length: 16'

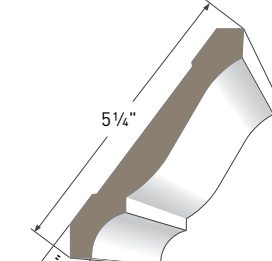

6" CROWN
AZM-45
Length: 16'

Detail and Sill/Drip Profiles

The AZEK Drip Cap can be used as a water table or brick ledge for separation and watershed against two different materials. AZEK's Sill profiles shed water and offer architectural detail.

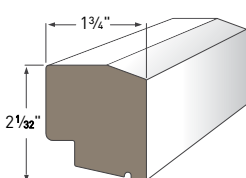

HISTORIC SILL
AZM-6930
Length: 16'

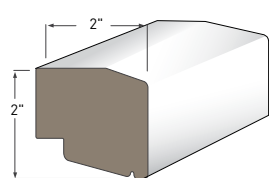

LARGE SILL NOSE
AZM-7979
Length: 16'

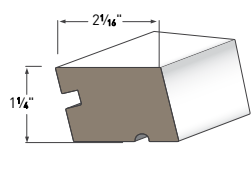

WINDOW SILL NOSE
AZM-7974
Length: 12'

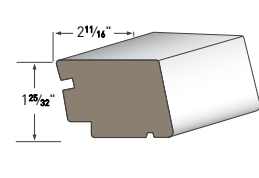

LARGE HISTORIC SILL
AZM-7958
Length: 16'

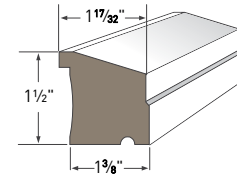

SUB SILL NOSE
AZM-6933
Length: 16'

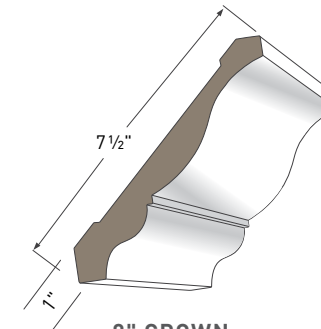

8" CROWN
AZM-43
Length: 16'

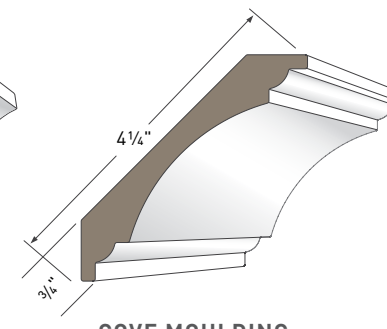

COVE MOULDING
AZM-80
Length: 16'

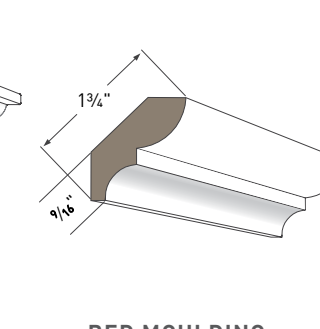

BED MOULDING
AZM-75
Length: 16'

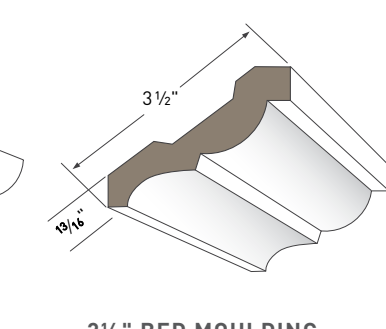

3 1/2" BED MOULDING
AZM-28
Length: 16'

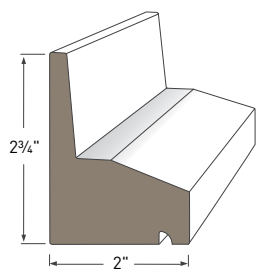

WATER TABLE
AZM-6935
Length: 18'

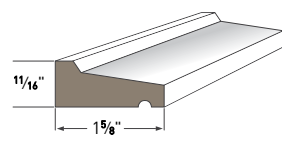

DRIP CAP
AZM-197
Length: 16'

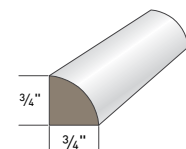

QUARTER ROUND
AZM-105
Length: 16'

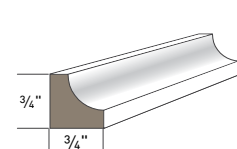

SCOTIA
AZM-93
Length: 16'

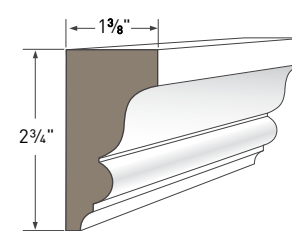

IMPERIAL RAKE CROWN
AZM-6937
Length: 16'

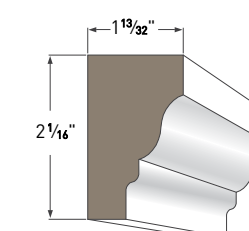

RAMS CROWN
AZM-6934
Length: 16'

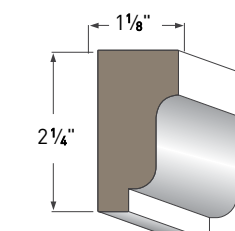

SOLID CROWN
AZM-7954
Length: 16'

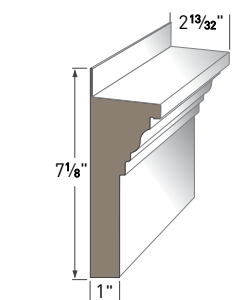

CROSSHEAD PEDIMENT
AZM-6216
Length: 18'

Casing Profiles

Use AZEK® Casing profiles as decorative mouldings against a wall, door, or window to create surrounds. Complement windows and doors with a single profile or combine multiple profiles for a personalized exterior transformation.

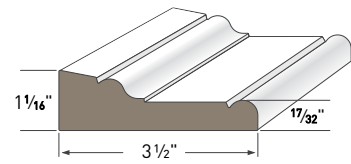

ADAMS CASING AZM-97
Length: 16'

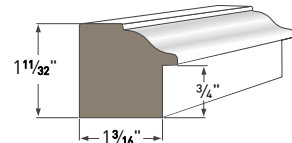

BACK BAND AZM-6931
Length: 16'

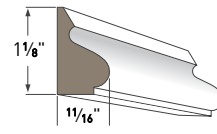

BASE CAP AZM-164
Length: 16'

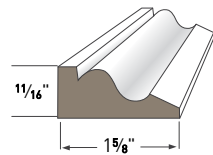

BAND MOULDING AZM-217
Length: 16'

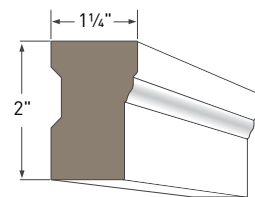

BRICK MOULD AZM-180
Lengths: 16, 17' and 18'

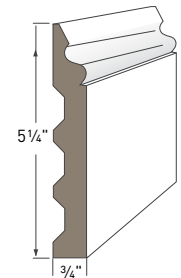

COLONIAL BASE CAP AZM-163
Length: 16'

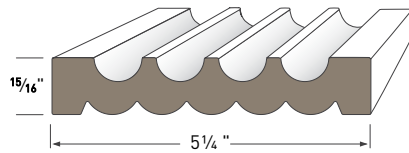

FLUTED/REEDED AZM-606
Length: 16'

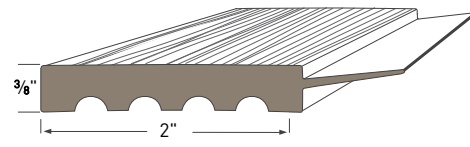

GARAGE DOOR THERMOSTOP AZM-6936
Lengths: 7', 9', and 16'

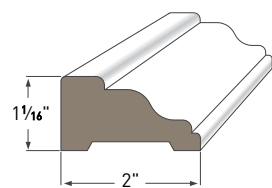

RAKE MOULDING AZM-287
Length: 16'

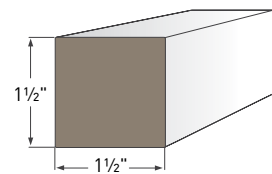

SQUARE PROFILE AZM-236
Length: 12'

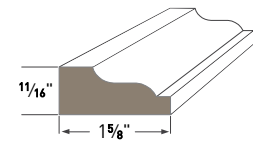

SHINGLE MOULD AZM-210
Length: 16'

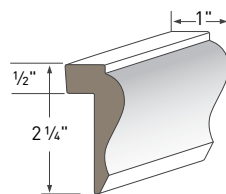

WAINSCOT CAP AZM-284
Length: 16'

| | AZEK Item Number | | | |
|---|------------------|--------------|-----------|-----------|
| | 12' | 16' | 17' | 18' |
| MOULDING | | | | |
| Actual | | | | |
| 9/16" x 2-3/4" 3" Crown AZM-52 | — | AMCM03192 | — | — |
| 9/16" x 3-5/8" 4" Crown AZM-49 | — | AMCM04192 | — | — |
| 11/16" x 4-5/8" 5" Crown AZM-47 | — | AMCM05192 | — | — |
| 11/16" x 5-1/4" 6" Crown AZM-45 | — | AMCM06192 | — | — |
| 1" x 7-1/2" 8" Crown AZM-43 | — | AMCM08192 | — | — |
| 3/4" x 4-1/4" Cove Moulding AZM-80 | — | AMCC05192 | — | — |
| 1-13/32" x 2-1/16" Rams Crown AZM-6934 | — | AMRC02192 | — | — |
| 1-3/8" x 2-3/4" Imperial/Rake Crown AZM-6937 | — | AMIR03192 | — | — |
| 9/16" x 1-3/4" Bed Moulding AZM-75 | — | AMBD02192 | — | — |
| 13/16" x 3-1/2" Bed Moulding AZM-28 | — | AMBD04192 | — | — |
| 3/4" x 3/4" Scotia AZM-93 | — | AMSC01192 | — | — |
| 3/4" x 3/4" Quarter Round AZM-105 | — | AMQR01192 | — | — |
| 11/16" x 1-5/8" Shingle Mould AZM-210 | — | AMSM02192 | — | — |
| 11/16" x 1-5/8" Band Moulding AZM-217 | — | AMBN02192 | — | — |
| 1" x 2-1/4" Wainscot Cap AZM-284 | — | AMWC03192 | — | — |
| 11/16" x 1-1/8" Base Cap AZM-164 | — | AMBC02192 | — | — |
| 1-1/4" x 2" Brick Mould AZM-180 | — | AMBM02192 | AMBM02204 | AMBM02216 |
| 1-11/32" x 1-3/16" Back Band AZM-6931 | — | AMBB02192 | — | — |
| 1-1/16" x 2" Rake Moulding AZM-287 | — | AMRM02192 | — | — |
| 1-1/16" x 3-1/2" Adams Casing AZM-97 | — | AMAC04192 | — | — |
| 3/4" x 5-1/4" Colonial Base Cap AZM-163 | — | AMCB06192 | — | — |
| 15/16" x 5-1/4" Fluted/Reeded Casing AZM-606 | — | AMFR06192 | — | — |
| Crosshead Pediment AZM-6216 | — | — | — | AMCP04216 |
| 1-1/2" x 1-1/2" Square AZM-236 | AMIC02144 | — | — | — |
| 11/16" x 1-5/8" Drip Cap AZM-197 | — | AMDC02192 | — | — |
| 2-3/4" x 2" Water Table AZM-6935 | — | — | — | AMWT03216 |
| 1-3/4" x 2-1/32" Historic Sill AZM-6930 | — | AMHS02192 | — | — |
| 1-17/32" x 1-1/2" x 1-3/8" Sub Sill Nose AZM-6933 | — | AMSS02192 | — | — |
| 1-1/8" x 2-1/4" Solid Crown AZM-7954 | — | AMCM02192CB | — | — |
| 1-25/32" x 2-11/16" Large Historic Sill AZM-7958 | — | AMHS03192CB | — | — |
| 2" x 2" Large Sill Nose AZM-7979 | — | AMLSN02192CB | — | — |
| 1-1/4" x 2-1/16" Window Sill Nose AZM-7974 | AMWSN02144CB | — | — | — |

| | AZEK Item Number | | | | |
|---|------------------|-----------|-----|-----------|-----|
| | 7' | 9' | 12' | 16' | 18' |
| GARAGE DOOR THERMOSTOP AZM-6936 | | | | | |
| Actual | | | | | |
| 3/8" x 2" Garage Door Thermostop AZM-6936 | AMGT03084 | AMGT03108 | — | AMGT03192 | — |

Industry Leading Warranties

With decades in the business partnered with dedicated investments to research and development, AZEK makes it our mission to provide the best materials on the market. We guarantee the integrity of our siding, cladding, trim and moulding with a lifetime limited warranty that covers rotting, splitting, splintering, peeling and warping. It is also easy to maintain and resistant to mold, mildew and moisture damage. For more information, visit AZEKexteriors.com/warranty.

Contractor and Builder Information

AZEK® Siding, Cladding, Trim & Moulding should be installed using the same good building principles used to install wood trim and mouldings and in accordance with the local building codes and established installation guidelines. AZEK accepts no liability or responsibility for the improper installation of this product.

AZEK® Siding, Cladding, Trim & Moulding may not be suitable for every application and it is the sole responsibility of the installer to be sure that AZEK Siding, Cladding, Trim and Moulding are fit for the intended use. Since all installations are unique, it is also the installer's responsibility to determine specific requirements in regard to each application. AZEK recommends that all applications be reviewed by a licensed architect, engineer or local building official before installation.



AZEK Shingle Siding with PaintPro® Technology

Made from a state-of-the-art proprietary engineered polymer, AZEK® Shingle matches the attractive texture of cedar shingles while adding the performance and low-maintenance benefits of rot-proof PVC building materials. Leveraging our innovative new PaintPro Technology, AZEK Shingle offers a rapid dry time, superior paint adhesion, and a painted finish that lasts without needing touch-ups or frequent maintenance.



Straight Edge Shingle

Consistency with a dash of variety. Uniform horizontal lines with varied width tabs and keyways for the most natural-looking shingle to beautifully complement modern or classic exterior architecture.



Staggered Edge Shingle

Patterns with individual character, dimension, and diversity. Each random edge panel enhances the overall pattern for an amazing exterior picture. Beautiful variety in both vertical and horizontal lines.

| SHINGLE SIDING | | |
|--|------------------|----------------|
| 5" Reveal Straight Edge Shingle Panel | 48" x 12" x 1/4" | ASSTRE02512048 |
| 7" Reveal Straight Edge Shingle Panel | 48" x 16" x 1/4" | ASSTRE02516048 |
| 6" Reveal Staggered Edge Shingle Panel | 48" x 15" x 1/4" | ASSTGE02515048 |



Board and Batten

Both AZEK Sheet (board) and Trim Boards (Batten Strips) are made from moisture-resistant, premium cellular PVC engineered to endure. For a finished look that requires paint, use board and batten enhanced with AZEK PaintPro Technology. If a timeless white board and batten look is desired, use AZEK Classic that comes in a semimatte white and requires no painting. See full listing of trim board and sheet sizes on pages 5-6.

| | | AZEK Item Number | |
|---|---------------|------------------|--------------|
| | | 12' | 16' |
| Batten Strips with PaintPro® Technology | | | |
| Nominal | Actual | | |
| 4/4 x 2 | 3/4" x 1-1/2" | — | AF10002192PP |
| 4/4 x 3 | 3/4" x 2-1/2" | — | AF10003192PP |

| | | AZEK Item Number | | |
|--|---------------|------------------|--------------|-----|
| | | 8' | 10' | 12' |
| Boards (PVC Sheet) s with PaintPro® Technology | | | | |
| Actual | | | | |
| 3/4 x 4 | ASF03448096PP | ASF03448096PP | — | — |
| 1/2 x 4 | ASF01248096PP | ASF01248120PP | ASF0128144PP | — |



AZEK® Cladding

AZEK Capped Polymer Cladding offers a wide range of color options, multiple board widths and offers both tongue-and-groove (closed-joint) and square shoulder boards (open-joint). For full listing of cladding plank colors and sizes see the sku information from the TimberTech AZEK Vintage Collection® on page 3.



Approved for Residential and Commercial

AZEK Capped Polymer Cladding is approved for commercial, residential and multi-family projects. With AZEK Cladding, you lock in exclusive application options for your uniquely beautiful design.



Adhesive and Tools

Quickly, easily and securely bond AZEK trim to multiple surfaces with AZEK adhesives engineered specifically to bond with PVC products. Get a permanent solution for core-to-core bonding, surface bonding, sealing and filling PVC trim and moulding for an attractive finish.

| | AZEK Item Number | | | | | |
|---------------------|------------------|----------|----------|----------|----------|----------|
| | 4 OZ | 8 OZ | 16 OZ | 32 OZ | 128 OZ | 640 OZ |
| PVC CEMENT | | | | | | |
| Cellular PVC Cement | AAD004OZ | AAD008OZ | AAD016OZ | AAD032OZ | AAD128OZ | AAD640OZ |

| | AZEK Item Number | | | | | |
|----------------------------------|------------------|-----------|-------|-------|--------|--------|
| | 4 OZ | 8 OZ | 16 OZ | 32 OZ | 128 OZ | 640 OZ |
| PVC CEMENT SQUEEZE BOTTLE | | | | | | |
| Cellular PVC Cement | AADB004OZ | AADB008OZ | | | | |

| | AZEK Item Number | | |
|--|---|-------------|---------------|
| | | 50 ML | 220 ML |
| FAST CURE/SLOW CURE ADHESIVES & TOOLS | | | |
| Fast Cure Structural Starter Kit | Includes 2 mixers, 50 ml adhesive and caulk gun adapter | AAD50MLFCSK | — |
| Slow Cure Structural Starter Kit | Includes 2 mixers, 50 ml adhesive and caulk gun adapter | AAD50MLSCSK | — |
| Fast Cure Structural Adhesive | | AAD50MLFCS | AAD220MLMLFCS |
| Slow Cure Structural Adhesive | | AAD50MLSCS | AAD220MLSCS |
| Qwik-Mixers | | AAD50MLSQM | AAD220MLQM |
| Manual Dispense Gun | | AAD50MLMG | AAD220MLHF |
| Fill & Flex Caulking Gun Adapter, 300 ml | AAD50MLCGA | | |

| | AZEK Item Number |
|---------------------------------|------------------|
| ADHESIVE & TOOLS | |
| Fill & Flex, 300 ml | AAD300MLFF |
| Nail Eraser, 0.5 oz | AADNEBLIS |
| Plastic Joining Biscuits | AADPJB |
| AZEK Adhesive Opening Order SKU | AAD14P00S |



Fast Cure Adhesive

White, two-part acrylic-based adhesive ideal for bonding AZEK to AZEK products. Also bonds PVC to wood, metal, brick, vinyl, glass and other PVC. Work time 4-7 minutes at 70°F. Fully cures in 24 hours. Fills nail holes and gaps up to 1/8". Requires Qwik-Mixer for easy mixing and dispensing.



Slow Cure Adhesive

White, two-part acrylic-based adhesive ideal for bonding AZEK to AZEK products. Also bonds PVC to wood, metal, brick, vinyl, glass and other PVC. Work time 15-25 minutes at 70°F. Fully cures in 24 hours. Fills nail holes and gaps up to 1/2". Requires Qwik-Mixer for easy mixing and dispensing.



Cellular PVC Cement

Clear, contact-style adhesive bonds with PVC in a fast working time. Ideal for securing joints. Creates a powerful and reliable material bond with no sanding or scraping required. Use AZEK Cellular PVC Cement to connect trim when a tight compression is required, such as connecting trim end-to-end (scarf joints) and at corners (miter joints).



Fill & Flex

Use for expansion and contraction joints on PVC trim boards. Seals gaps around windows and doors. Slow curing, one-part, urethane-based sealant with high level of flexibility and elongation to absorb expansion and contraction from heat or cold.

Adhesive Accessories



QWIK-MIXERS
50 ml: AAD50MLSQM,
220 ml: AAD220MLQM

Required dispenser for Fast Cure and Slow Cure AZEK Adhesive products. The resin and catalyst blend together as they travel down the tube to the applicator tip. Ensures 1:1 ratio mix and provides easy adhesive application. 24 per pack.



NAIL ERASER
Fills finish nail and brad holes in PVC trim board. Resists yellowing. .5oz



MANUAL 220 ML DISPENSING GUN
Its 26:1 mechanical advantage dispenses high and low viscosity adhesives with less user fatigue. Designed to maximize durability.



MANUAL 50 ML DISPENSING GUN
Made of highly engineered plastic to be lightweight and powerful. Easy loading breech provides secure cartridge fit.



CAULKING GUN ADAPTER
Tool adapter for caulking guns.



PLASTIC JOINING BISCUITS
Easy way to join, seal and finish PVC trim. 50 per pack



CORTEX®

Save time, money, and labor costs with Cortex for AZEK® Trim. The only concealed fastening system that quickly and easily fastens AZEK Trim to your building project comes with collated strips to make fastening up to 50% faster. The felt tip on the unique bit prevents surface marring while driving fasteners securely below the trim surface. Plugs made of AZEK Trim tap in for a clean, flush finish. No mess and no fading over the life of the project. Plus, Cortex fasteners offer a stronger connection than nails.

Cortex Benefits

- Fast and easy: eliminates the need to caulk, sand and paint each nail hole
- Plugs made out of same AZEK material as trim; eliminates fading or streaking
- Can be painted
- Guaranteed corrosion resistance for life of the project; ACQ approved



| AZEK Item Number | |
|--|-----------|
| CORTEX® PLUGS, NO SCREWS | |
| Smooth Collated Cortex - 40 Plugs (no screws) | ATCTC40PC |
| Woodgrain Collated Cortex - 40 Plugs (no screws) | AFCTC40PC |

| | AZEK Item Number | | |
|---|------------------|---------------|---------------|
| | 50 LN FT | 250 LN FT | 750 LN FT |
| SCREW, PLUG AND BIT KITS | | | |
| Smooth Cortex 2" Screws | ATCTL50LF200 | ATCTL250LF200 | ATCTL750LF200 |
| Smooth Collated Cortex 2" Screws | — | ATCTC250LF200 | ATCTC750LF200 |
| Smooth Cortex 2-3/4" Screws | ATCTL50LF275 | ATCTL250LF275 | ATCTL750LF275 |
| Smooth Collated Cortex 2-3/4" Screws | — | ATCTC250LF275 | ATCTC750LF275 |
| Woodgrain Cortex 2" Screws | AFCTL50LF200 | AFCTL250LF200 | AFCTL750LF200 |
| Woodgrain Collated Cortex 2" Screws | — | AFCTC250LF200 | AFCTC750LF200 |
| Woodgrain Cortex 2-3/4" Screws | AFCTL50LF275 | AFCTL250LF275 | AFCTL750LF275 |
| Woodgrain Collated Cortex 2-3/4" Screws | — | AFCTC250LF275 | AFCTC750LF275 |

| | AZEK Item Number | | |
|---|------------------|-----------------|-----------------|
| | 50 LN FT | 250 LN FT | 750 LN FT |
| PAINTPRO® SCREW, PLUG AND BIT KITS | | | |
| Smooth Collated Cortex 2" Screws | — | ATCTC250LF200PP | ATCTC750LF200PP |
| Smooth Collated Cortex 2-3/4" Screws | — | ATCTC250LF275PP | ATCTC750LF275PP |
| Woodgrain Collated Cortex 2" Screws | — | AFCTC250LF200PP | AFCTC750LF200PP |
| Woodgrain Collated Cortex 2-3/4" Screws | — | AFCTC250LF275PP | AFCTC750LF275PP |



Paintable Cortex
or PaintPro Trim



 **TimberTech**[®]
Go Against the Grain.[™]

AZEK[®]
Exteriors

The AZEK[®] Company

1330 W. Fulton Street, Suite 350 | Chicago, IL 60607

LIT-PRODUCTGUIDE REV 11/21